

Panasonic®

Basic Owner's Manual Digital Camera

Model No. **DC-FZ1000M2**

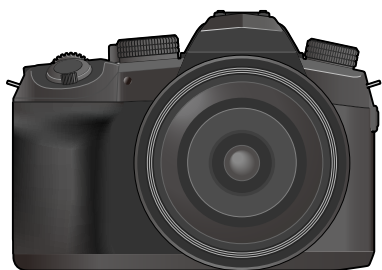

LUMIX

Please read these instructions carefully before using this product, and save this manual for future use.

More detailed owner's manual is available in "Owner's Manual for advanced features (PDF format)". To read it, download it from the website. (→89)

Register online at <http://shop.panasonic.com/support> (U.S. customers only)

If you have any questions, visit:
USA : <http://shop.panasonic.com/support>
Canada : www.panasonic.ca/english/support

**Dear Customer,
Thank you for choosing Panasonic!**

You have purchased one of the most sophisticated and reliable products on the market today. Used properly, we're sure it will bring you and your family years of enjoyment. Please take time to fill in the information below. The serial number is on the tag located on the underside of your camera. Be sure to **retain this manual** as your convenient camera information source.

Date of Purchase	Dealer Phone No.
Dealer Purchased From	Model No.
Dealer Address	Serial No.

Please note that the actual controls and components, menu items, etc. of your Digital Camera may look somewhat different from those shown in the illustrations in this Owner's Manual.

Carefully observe copyright laws.

- Recording of pre-recorded tapes or discs or other published or broadcast material for purposes other than your own private use may infringe copyright laws. Even for the purpose of private use, recording of certain material may be restricted.

For the U.S.A. and Canada only



A lithium ion battery that is recyclable powers the product you have purchased. Please call 1-800-8-BATTERY for information on how to recycle this battery.

Information for Your Safety

WARNING:

- To reduce the risk of fire, electric shock or product damage,
- Do not expose this unit to rain, moisture, dripping or splashing.
 - Use the recommended accessories.
 - Do not remove covers.
 - Do not repair this unit by yourself. Refer servicing to qualified service personnel.

The socket outlet shall be installed near the equipment and shall be easily accessible.

■ Product identification marking

Product	Location
Digital camera	Bottom

THE FOLLOWING APPLIES ONLY IN THE U.S.A.

Certification and Compliance

Please select as follows:

MENU →  **[Setup]** → **[Approved Regulations]**

Contains FCC ID : VPYLB1JS955

This transmitter must not be co-located or operated in conjunction with any other antenna or transmitter.

This equipment complies with FCC radiation exposure limits set forth for an uncontrolled environment and meets the FCC radio frequency (RF) Exposure Guidelines. This equipment has very low levels of RF energy that is deemed to comply without testing of specific absorption rate (SAR).



THE FOLLOWING APPLIES ONLY IN THE U.S.A.

FCC Note:

This equipment has been tested and found to comply with the limits for a Class B digital device, pursuant to Part 15 of the FCC Rules. These limits are designed to provide reasonable protection against harmful interference in a residential installation. This equipment generates, uses, and can radiate radio frequency energy and, if not installed and used in accordance with the instructions, may cause harmful interference to radio communications. However, there is no guarantee that interference will not occur in a particular installation. If this equipment does cause harmful interference to radio or television reception, which can be determined by turning the equipment off and on, the user is encouraged to try to correct the interference by one or more of the following measures:

- Reorient or relocate the receiving antenna.
- Increase the separation between the equipment and receiver.
- Connect the equipment into an outlet on a circuit different from that to which the receiver is connected.
- Consult the dealer or an experienced radio/TV technician for help.

FCC Caution: To assure continued compliance, follow the attached installation instructions and use only shielded interface cables with ferrite core when connecting to computer or peripheral devices.

Any unauthorized changes or modifications to this equipment would void the user's authority to operate this device.

This device complies with Part 15 of the FCC Rules. Operation is subject to the following two conditions: (1) This device may not cause harmful interference, and (2) this device must accept any interference received, including interference that may cause undesired operation.

Supplier's Declaration of Conformity

Trade Name: Panasonic

Model No.: DC-FZ1000M2

Responsible Party: Panasonic Corporation of North America

Two Riverfront Plaza, Newark, NJ 07102-5490

Support Contact: <http://shop.panasonic.com/support>

THE FOLLOWING APPLIES ONLY IN CANADA.

Certification and Compliance

Please select as follows:

MENU →  **[Setup]** → **[Approved Regulations]**

CAN ICES-3(B)/NMB-3(B)

Contains IC : 772C-LB1JS955

This device contains licence-exempt transmitter(s)/receiver(s) that comply with Innovation, Science and Economic Development Canada's licence-exempt RSS(s). Operation is subject to the following two conditions:

- (1) This device may not cause interference.
- (2) This device must accept any interference, including interference that may cause undesired operation of the device.

The available scientific evidence does not show that any health problems are associated with using low power wireless devices. There is no proof, however, that these low power wireless devices are absolutely safe. Low power Wireless devices emit low levels of radio frequency energy (RF) in the microwave range while being used. Whereas high levels of RF can produce health effects (by heating tissue), exposure of low-level RF that does not produce heating effects causes no known adverse health effects. Many studies of low-level RF exposures have not found any biological effects. Some studies have suggested that some biological effects might occur, but such findings have not been confirmed by additional research. DC-FZ1000M2 (HMN is 1JS1903) has been tested and found to comply with ISED radiation exposure limits set forth for an uncontrolled environment and meets RSS-102 of the ISED radio frequency (RF) Exposure rules.

■ About the battery pack

CAUTION

Battery pack (Lithium ion battery pack)

- Use the specified unit to recharge the battery pack.
- Do not use the battery pack with equipment other than the specified unit.
- Do not get dirt, sand, liquids, or other foreign matter on the terminals.
- Do not touch the plug terminals (+ and -) with metal objects.
- Do not disassemble, remodel, heat or throw into fire.

If any electrolyte should come into contact with your hands or clothes, wash it off thoroughly with water.

If any electrolyte should come into contact with your eyes, never rub the eyes. Rinse eyes thoroughly with water, and then consult a doctor.

CAUTION

- Danger of explosion if battery is incorrectly replaced. Replace only with the type recommended by the manufacturer.
- When disposing of the batteries, please contact your local authorities or dealer and ask for the correct method of disposal.

- Do not heat or expose to flame.
- Do not leave the battery(ies) in a car exposed to direct sunlight for a long period of time with doors and windows closed.

Warning

Risk of fire, explosion and burns. Do not disassemble, heat above 60 °C (140 °F) or incinerate.

■ About the AC adaptor (supplied)

CAUTION!

To reduce the risk of fire, electric shock or product damage,
• **Do not install or place this unit in a bookcase, built-in cabinet or in another confined space. Ensure this unit is well ventilated.**

AC adaptor

This AC adaptor operates on AC between 110V and 240V.

But

- In the U.S.A. and Canada, the AC adaptor must be connected to a 120V AC power supply only.
- When connecting to an AC supply outside of the U.S.A. or Canada, use a plug adaptor to suit the AC outlet configuration.

■ Cautions for Use

- Do not use any other USB connection cables except the supplied one.
- Use a "High Speed HDMI micro cable" with the HDMI logo.
Cables that do not comply with the HDMI standards will not work.
"High Speed HDMI micro cable" (Type D - Type A plug, up to 2 m (6.6 feet) long)
- Always use a genuine Panasonic shutter remote control (DMW-RS2: optional).
- Do not use the Stereo microphone cables with the length of 3 m (9.8 feet) or more.

Keep this unit as far away as possible from electromagnetic equipment (such as microwave ovens, TVs, video games etc.).

- If you use this unit on top of or near a TV, the pictures and/or sound on this unit may be disrupted by electromagnetic wave radiation.
- Do not use this unit near cell phones because doing so may result in noise adversely affecting the pictures and/or sound.
- Recorded data may be damaged, or pictures may be distorted, by strong magnetic fields created by speakers or large motors.
- Electromagnetic wave radiation may adversely affect this unit, disturbing the pictures and/or sound.
- If this unit is adversely affected by electromagnetic equipment and stops functioning properly, turn this unit off and remove the battery or disconnect AC adaptor. Then reinsert the battery or reconnect AC adaptor and turn this unit on.

Do not use this unit near radio transmitters or high-voltage lines.

- If you record near radio transmitters or high-voltage lines, the recorded pictures and/or sound may be adversely affected.

-
- To clean your camera, remove the battery, the DC coupler (DMW-DCC8: optional) or a card, or disconnect the power plug from the outlet, and wipe with a soft, dry cloth.
 - Do not press the monitor with excessive force.
 - Do not press the lens with excessive force.
 - Do not allow camera to come into contact with pesticides or volatile substances (can cause surface damage or coating to peel).
 - Do not keep rubber or plastic products in contact with the camera for a long period of time.
 - Do not use solvents such as benzene, thinner, alcohol, kitchen detergents, etc., to clean the camera, since it may deteriorate the external case or the coating may peel off.
 - Do not leave the camera with the lens facing the sun, as rays of light from the sun may cause it to malfunction.
 - Always use the supplied cords and cables.
 - Do not extend the supplied cord or cable.
 - While the camera is accessing the card (for an operation such as picture writing, reading, deletion, or formatting), do not turn off the camera or remove the battery, card, AC adaptor (DMW-AC10PP: optional) or DC coupler (DMW-DCC8: optional). Furthermore, do not subject the camera to vibration, impact or static electricity.
 - The data on the card may be damaged or lost due to electromagnetic waves, static electricity or breakdown of the camera or the card. We recommend storing important data on a PC etc.
 - Do not format the card on your PC or other equipment. Format it on the camera only to ensure proper operation.

-
- **The battery is not charged when the camera is shipped. Charge the battery before use.**
 - **The battery is a rechargeable lithium ion battery. If the temperature is too high or too low, the operating time of the battery will become shorter.**
 - The battery becomes warm after using and during and after charging. The camera also becomes warm during use. This is not a malfunction.
 - **Do not leave any metal items (such as clips) near the contact areas of the power plug or near the batteries.**
 - Store the battery in a cool and dry place with a relatively stable temperature. (Recommended temperature: 15 °C to 25 °C (59 °F to 77 °F), Recommended humidity: 40%RH to 60%RH)
 - **Do not store the battery for a long time while fully charged.** When storing the battery for a long period of time, we recommend charging it once a year. Remove the battery from the camera and store it again after it has completely discharged.
-

Contents

■ Information for Your Safety	2
Preparations/Basics	
■ Before use	10
■ Standard accessories	11
■ Digital Camera Accessory System ...	12
■ Names and Functions of Main Parts	13
■ About the Card	15
■ Quick Start Guide	16
Attaching the Lens Cap	16
Attaching the Shoulder Strap	16
Attaching the Lens Hood	17
Inserting the battery and/or SD memory card (optional)	18
Charging the battery	19
Opening the Monitor	21
Setting the clock	21
[LVF] button (Recording pictures using the viewfinder)	22
Holding the camera	22
Shutter button (Taking pictures)	23
■ Basic operations	24
■ Setting the menu	30
Recording	
■ Taking pictures with automatic settings (Intelligent Auto Mode)	32
■ Taking pictures with Auto Focus	34
■ Taking pictures with Manual Focus	36
■ Focus, Brightness (Exposure) and Color tone Settings	37
■ Selecting a Drive Mode ([Burst] / [Self Timer])	41
■ Recording with the 4K Photo function	42
■ Adjusting the focus after recording ([Post Focus] / [Focus Stacking])	45
■ Taking Pictures with Time Lapse Shot/Stop Motion Animation	47
■ Taking Pictures While Adjusting a Setting Automatically (Bracket Recording)	49
■ Taking pictures with flash	51
■ Recording Motion Picture/ 4K Motion Picture	52
Playback	
■ Viewing your pictures	56
■ Deleting pictures	58
Menu	
■ Menu list	59
Wi-Fi/Bluetooth	
■ What you can do with the Wi-Fi®/Bluetooth® function	71
■ Operating the camera by connecting it to a smartphone ...	72
Others	
■ Downloading software	78
■ List of monitor/viewfinder displays	79
■ Q&A Troubleshooting	82
■ Specifications	86
■ Reading the Owner's Manual (PDF format)	89
■ Limited Warranty (ONLY FOR U.S.A.)	90
■ Limited Warranty (ONLY FOR CANADA)	93

Before use

■ Camera handling

Keep the camera away from excessive vibration, force, or pressure.

- Avoid using the camera under the following conditions, which may damage the lens, monitor, viewfinder, or camera body. This may also cause the camera to malfunction or prevent recording.
 - Dropping or hitting the camera against a hard surface
 - Pushing with excessive force on the lens or monitor

The camera is not dust resistant, splash resistant, or waterproof.

Avoid using the camera in places with excessive dust or sand, or where water can come into contact with the camera.

If sand, dust, or liquids such as water droplets adhere to the monitor, wipe them off with a dry soft cloth.

- Not doing so may cause the monitor to respond incorrectly to touch operations.

■ Condensation (When the lens, the monitor, or viewfinder, is fogged up)

- Condensation may occur when the camera is exposed to sudden changes of temperature or humidity. Avoid these conditions, which may make the lens, monitor, or viewfinder dirty, cause mold, or damage the camera.
- If condensation does occur, turn off the camera and wait about two hours before using it. Once the camera adjusts to the surrounding temperature, the fogging will clear naturally.

■ When in use

Do not keep objects such as credit cards that may be influenced magnetically close to this unit. The data on these objects may become corrupted and unusable.

■ About the symbols in the text

MENU Indicates that the menu can be set by pressing [MENU/SET] button.

Steps for setting a menu item are described as follows:

MENU →  **[Rec]** → **[Quality]** → **[.+.]**



In Recording modes that show icons in black, you can select and execute indicated menus and functions.

-  (Custom Mode) has different functions depending on the recording mode that is registered.

Recording mode:   **P** **A** **S** **M**   

Standard accessories

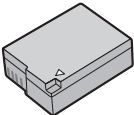
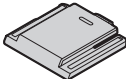
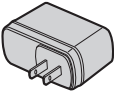
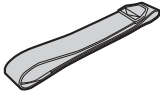
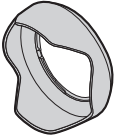
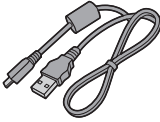
Check that all the accessories are supplied before using the camera. Part numbers are as of February 2019. These may be subject to change.

<input type="checkbox"/> Battery pack DMW-BLC12PP  <ul style="list-style-type: none"> • Charge the battery before use. • Battery pack is indicated as battery pack or battery in the text. 	<input type="checkbox"/> Hot shoe cover SKF0106K  (This is attached to the camera at the time of purchase.)
<input type="checkbox"/> AC adaptor VSK0815F 	<input type="checkbox"/> Shoulder Strap DVPW1002Z 
<input type="checkbox"/> Lens hood SYQ0081 	<input type="checkbox"/> USB connection cable K1HY04YY0106 
<input type="checkbox"/> Lens cap/ Lens cap string 1ZE1DCFZ1000M2Z 	

- **Cards are optional.** (SD Memory Card, SDHC Memory Card and SDXC Memory Card are indicated as card in the text.)

(For U.S.A. only)

- If accessories are lost, customers can visit us at <http://shop.panasonic.com/support> for further information about obtaining replacement parts.

(For Canada only)

- If any accessories are lost, customers in Canada should visit our support page at www.panasonic.ca/english/support for further information about obtaining replacement parts.
- Please dispose of all packaging appropriately.
- The illustrations and screens in this manual may differ from the actual product.

Digital Camera Accessory System

Description	Accessory#
Battery pack	DMW-BLC12
Battery charger	DMW-BTC12
AC adaptor*	DMW-AC10
DC coupler*	DMW-DCC8
Flash	DMW-FL200L, DMW-FL360L, DMW-FL580L
Shutter remote control	DMW-RS2
LED video light	VW-LED1
Stereo shotgun microphone	DMW-MS2
Stereo microphone	VW-VMS10
MC protector	DMW-LMCH62
PL filter (Circular type)	DMW-LPL62
Shoulder Strap	DMW-SSTG9

* The AC adaptor (optional) can only be used with the designated Panasonic DC coupler (optional). The AC adaptor (optional) cannot be used by itself. When using an AC adaptor (optional), use the AC cable supplied with the AC adaptor.

- Part numbers are as of February 2019. These may be subject to change.
- Some optional accessories may not be available in some countries.
- (For U.S.A. only)
To order optional accessories please visit <http://shop.panasonic.com> or your local Photo Specialty Dealer.

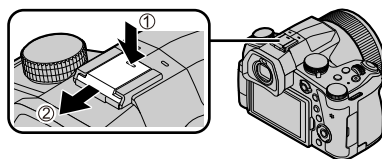

■ Removing the Hot Shoe Cover

Remove the hot shoe cover by pulling it in the direction indicated by arrow ② while pressing it in the direction indicated by arrow ①.

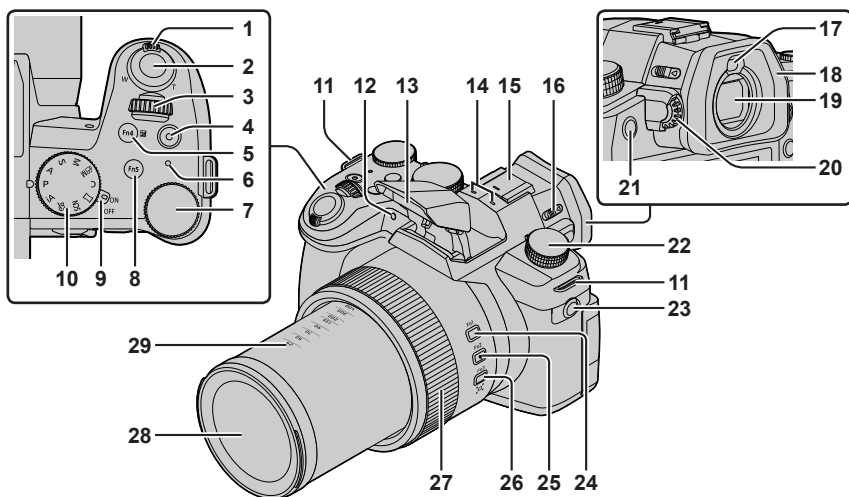

Names and Functions of Main Parts



- | | | | |
|----|---|----|---|
| 1 | Zoom lever (→24) | 17 | Eye sensor (→22) |
| 2 | Shutter button (→23) | 18 | Eyecup |
| 3 | Front dial (→26) | 19 | Viewfinder (→22) |
| 4 | Motion picture button (→52) | 20 | Diopter adjustment dial (→22) |
| 5 | [Fn4] button (→31) /
[] (Exposure Compensation) button
(→37) | 21 | [Fn8] button (→31) / [LVF] button (→22) |
| 6 | Charging lamp (→20) /
WIRELESS connection lamp (→71) | 22 | Drive mode dial (→41) |
| 7 | Rear dial (→26) | 23 | [MIC] socket |
| 8 | [Fn5] button (→31) | 24 | [Fn1] button (→31) |
| 9 | Camera [ON/OFF] switch (→21) | 25 | [Fn2] button (→31) |
| 10 | Mode dial (→25) | 26 | [Fn3] button (→31) /
[] ([Zoom Compose Assist]) button
(→24) |
| 11 | Shoulder strap eyelet (→16) | 27 | Control ring (→26) |
| 12 | Self-timer indicator / AF Assist Lamp | 28 | Lens |
| 13 | Flash (→51) | 29 | Focal distance indication (as with a
35 mm film camera)
Values assume an aspect ratio of [3:2].
(When recording motion pictures, refer
to the focal length displayed on the
screen.) |
| 14 | Stereo microphone | | |
| 15 | Hot shoe (Hot shoe cover) (→12)
Keep the hot shoe cover out of reach of
children to prevent swallowing. | | |
| 16 | Flash open lever (→51) | | |

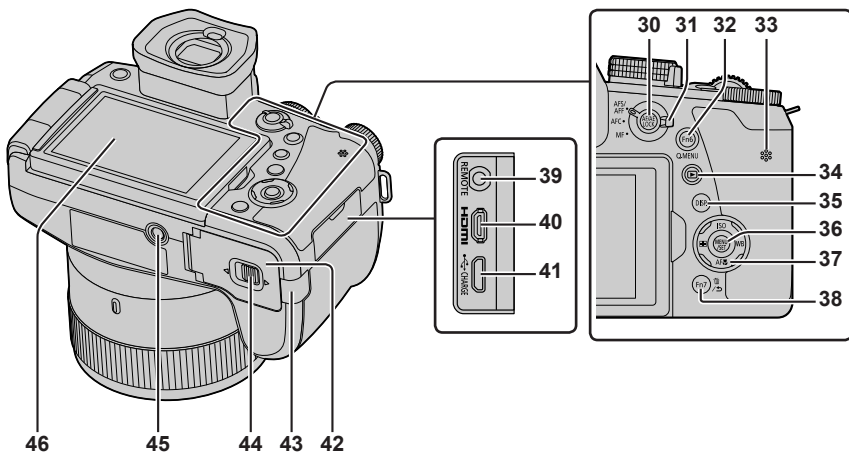

- 30 [AF/AE LOCK] button (→37)
- 31 Focus mode lever (→34, 36)
- 32 [Fn6] button (→31) / [Q.MENU] button (→31)
- 33 Speaker
- 34 [▶] (Playback) button (→56)
- 35 [DISP.] button (→27)
- 36 [MENU/SET] button (→27)
- 37 Cursor button (→27)
[ISO] (ISO sensitivity) (▲) (→38)
[WB] (White balance) (▶) (→39)
[AF] (Macro Mode) (▼) (→35)
[AF] (AF Mode) (◀) (→35)

- 38 [Fn7] button (→31) / [⏏] (Delete) button (→58) / [⏏] (Cancel) button (→30)
- 39 [REMOTE] socket
- 40 [HDMI] socket
You can view pictures on a TV screen by connecting your camera to your TV with the HDMI micro cable.
- 41 [USB/CHARGE] socket (→19)
- 42 Card/Battery door (→18)

- 43 DC coupler cover (→12)
 - Always use a genuine Panasonic AC adaptor (DMW-AC10PP: optional). (→12)
 - When using an AC adaptor, ensure that the Panasonic DC coupler (DMW-DCC8: optional) and AC adaptor (DMW-AC10PP: optional) are used.
- 44 Release lever (→18)
- 45 Tripod mount
Do not attach this unit to tripods that have screws with a length of 5.5 mm (0.22 inch) or more. Doing so may damage this unit or the unit may not be secured properly on the tripod.
- 46 Touch screen (→29) / monitor (→79)

Function buttons [Fn9] to [Fn13] are touch icons.

They can be displayed by touching the [Fn] tab on the recording screen.

About the Card





The following SD standard-based cards can be used.

Type of Card	Capacity	Notes
SD Memory Cards	512 MB – 2 GB	<ul style="list-style-type: none"> This unit is compatible with UHS-I UHS Speed Class 3 standard SDHC/SDXC memory cards. Operation of the cards listed on the left has been confirmed with Panasonic brand card.
SDHC Memory Cards	4 GB – 32 GB	
SDXC Memory Cards	48 GB – 128 GB	

■ About motion picture/4K photo recording and speed class ratings

Use a card that meets the following ratings of the SD Speed Class or UHS Speed Class.

- SD Speed Class and UHS Speed Class are the speed standards regarding continuous writing. Confirm the SD speed by checking the card label or other card related materials.

[Rec Format]	[Rec Quality]	Speed class	Label example
[AVCHD]	All	Class 4 or higher	CLASS  
[MP4]	[FHD]/[HD]		
	[4K]/[High Speed Video]	UHS Speed Class 3	
When recording in 4K Photo / [Post Focus]		UHS Speed Class 3	

- Latest information:
<https://panasonic.jp/support/global/cs/dsc/>
 (This site is available in English only.)
- Keep the memory card out of reach of children to prevent swallowing.

Formatting the card (initialization)

Format the card before recording a picture with this unit.

Since data cannot be recovered after formatting, make sure to back up necessary data in advance.

MENU →  **[Setup]** → **[Format]**

Quick Start Guide

Attaching the Lens Cap

Cover the lens with the lens cap to protect it when you are not taking pictures.

- Do not hang or swing around the camera with the lens cap string.
- Make sure to detach the lens cap when turning this unit on.
- Be careful that the lens cap string does not become entangled with the shoulder strap.

1 Use the lens cap string (supplied) to attach the lens cap to the camera

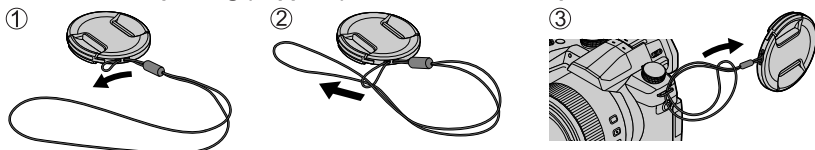

2 Attach the lens cap

- (A) Pinch here to attach or detach the cap.

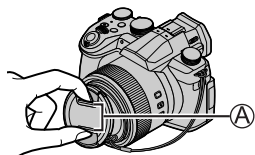

- Keep the lens cap string out of reach of children to prevent swallowing.

Attaching the Shoulder Strap

We recommend attaching the shoulder strap when using the camera to prevent it from dropping.

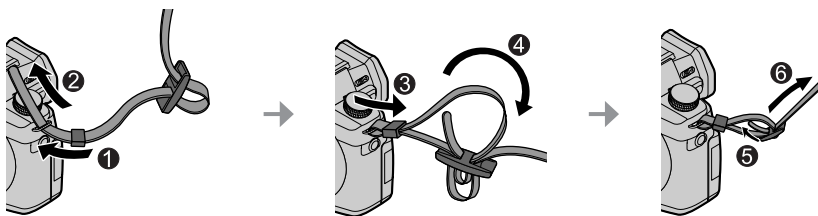

- Perform steps ① to ⑥ and then attach the other side of the shoulder strap.
- Use the shoulder strap around your shoulder.
 - Do not wrap the strap around your neck. It may result in injury or accident.
- Do not leave the shoulder strap where an infant can reach it.
 - It may result in an accident by mistakenly wrapping around the neck.

Attaching the Lens Hood

- Do not hold the lens hood in such a way that it will be bent.
- Make sure that the camera is turned off.
- Be sure to close the flash beforehand.



1 Align the mounting mark on the lens hood a little above the mounting mark on the tip of the lens

- Ⓐ Mounting mark on the tip of the lens
- Ⓑ Mounting mark on the lens hood

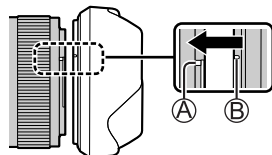

2 Turn the lens hood in the direction of the arrow to secure it

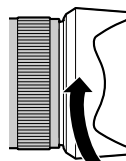

3 Continue to rotate the lens hood until you hear a “click” even if you feel some stiffness, and then align the mark on the bottom of the camera

- Make sure the lens hood is secured properly and its reflection does not fall on images.

- Ⓒ Rotate until the marks are aligned

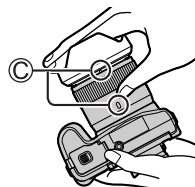

- If you attach the lens hood while using the flash, the flash light would be blocked by the lens hood causing the bottom part of images to be darkened (vignetting) and also making it impossible to modulate the light. It is recommended to remove the lens hood before using the flash.
- Temporarily Storing the Lens Hood

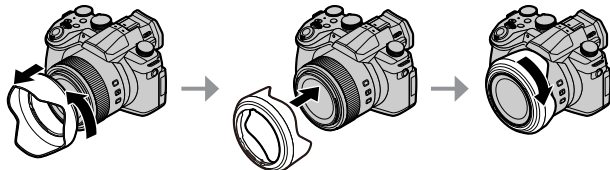

Inserting the battery and/or SD memory card (optional)

Make sure that the camera is turned off.

1 Slide the release lever (A) to the [OPEN] position and open the card/battery door

2 Insert the battery and card, making sure that their orientation is correct

- Battery: Insert the battery all the way firmly and check that it is locked by lever (B).
- Card: Insert the card all the way firmly until it clicks. Do not touch the terminal.

3 Close the door

Slide the release lever to the [LOCK] position.

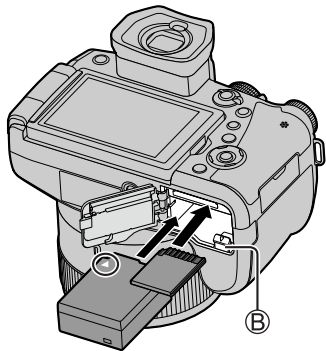
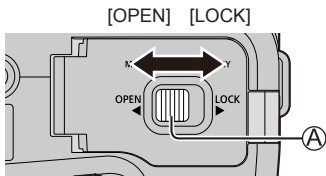

■ To remove

• To remove battery

Move lever (B) in direction of arrow.

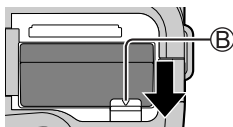

• To remove card

Press the center of the card.

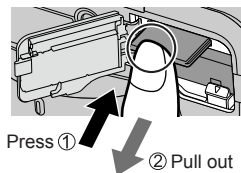

- Always use genuine Panasonic batteries (DMW-BLC12PP).
- If you use other batteries, we cannot guarantee the quality of this product.
- Turn the camera off and wait for the "LUMIX" display on the monitor to clear before removing the card or battery.

Charging the battery

- The battery that can be used with this unit is DMW-BLC12PP.
- We recommend charging in a location where the ambient temperature is between 10 °C and 30 °C (50 °F to 86 °F) (same for the battery temperature).

Insert the battery into the camera.

Make sure that the camera is turned off.

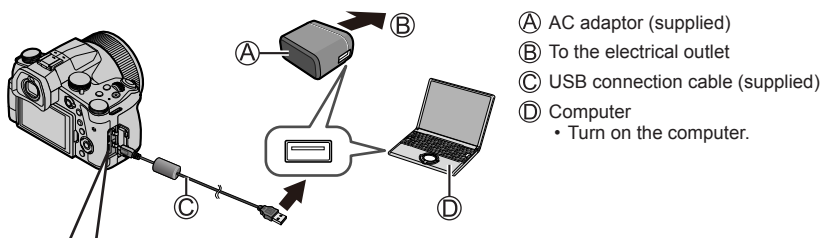

- Ⓐ AC adaptor (supplied)
- Ⓑ To the electrical outlet
- Ⓒ USB connection cable (supplied)
- Ⓓ Computer
 - Turn on the computer.

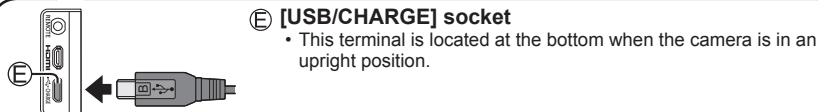

Ⓔ [USB/CHARGE] socket

- This terminal is located at the bottom when the camera is in an upright position.

- Always check the direction of the socket, and hold the plug straight to insert or remove it. (If the cable is inserted in the wrong direction, the socket could become deformed and cause faulty operation.) Also, do not insert into the wrong socket. Doing so may cause damage to this unit.

Charging from the power outlet

Connect the AC adaptor (supplied) and this camera with the USB connection cable (supplied), and insert the AC adaptor (supplied) into the power outlet.

Charging from a computer

Connect the computer and this camera with the USB connection cable (supplied).

■ Charging lamp indications

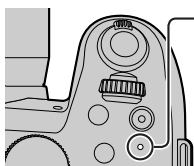

Charging lamp (Red)

On	Charging in progress
Off	Charging complete (After charging stops, disconnect the camera from the electrical outlet or your computer.)
Flashing	Charging error (→82)

■ Charging time

When using the AC adaptor (supplied)

Approx. 180 min.

- The charging time indicated above is the time required for charging in case when the battery is completely used up. The time required for charging differs depending on conditions of battery usage. Charging takes longer in cases when temperatures are either high or low and when the battery has not been used for a long period of time.
- The time required for charging through the computer varies depending on the power supply capacity of the computer.
- Do not use any other USB connection cables except the supplied one.
- Do not use any other AC adaptors except the supplied one.

Opening the Monitor

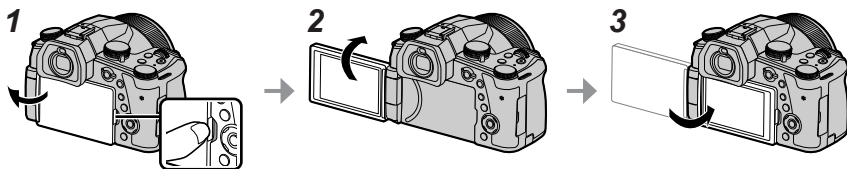

- 1** Place your finger in the cleft on the right side of the monitor and open the monitor toward the left side (maximum 180°)
- 2** It can be rotated 180° to the direction of the lens
- 3** Return the monitor to its original position

- Only rotate the monitor after opening it wide enough, and be careful not to use excessive force. Doing so may cause damage to this unit.
- When not using the monitor it is recommended that you close it with the screen facing inward to prevent dirt and scratches.

Setting the clock

The clock is not set when the camera is shipped.

- 1** Turn the camera on
- 2** Press [MENU/SET]
- 3** Press ▲▼ to select the language and press [MENU/SET]
 - The [Please set the clock] message appears.
- 4** Press [MENU/SET]
- 5** Press ◀▶ to select the items (year, month, day, hour, minute), and press ▲▼ to set
- 6** Press [MENU/SET]
- 7** When [The clock setting has been completed.] is displayed, press [MENU/SET]
- 8** When [Please set the home area] is displayed, press [MENU/SET]
- 9** Press ◀▶ to set your home area and press [MENU/SET]

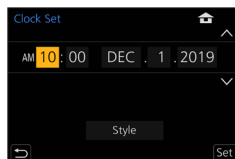
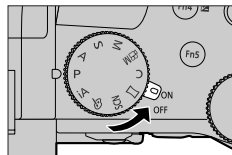

[LVF] button (Recording pictures using the viewfinder)

1 Press [LVF] (A) button

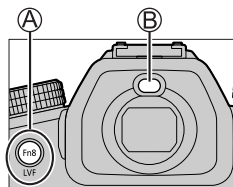

Automatic switching between
viewfinder and monitor



Viewfinder display



Monitor display



■ Automatic switching between viewfinder and monitor

The eye sensor (B) automatically switches the display to viewfinder when your eye or an object moves close to the viewfinder. When the eye or object moves away from the viewfinder, the camera returns to monitor display.

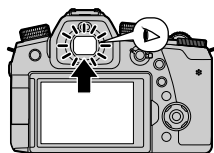

■ About diopter adjustment

Rotate the diopter adjustment dial to adjust until you are able to clearly see the characters displayed in the viewfinder.

- If [LVF Display Speed] is set to [ECO 30fps] when the viewfinder is used, the camera can be operated for a longer period since battery drainage is reduced.

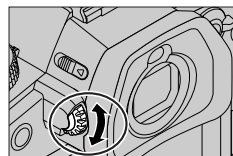

Holding the camera

- Do not block the flash, AF Assist Lamp, microphone, or speaker with your fingers or other objects.

- (A) Speaker
- (B) AF Assist Lamp
- (C) Microphone

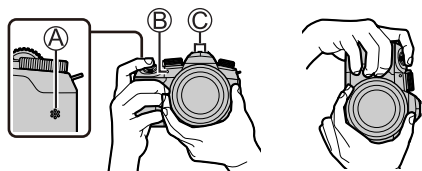

- Do not hold the lens barrel as you take pictures. There is a risk that your finger will be trapped as the lens retracts.

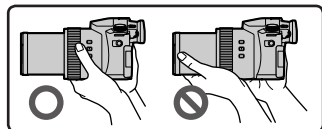

■ Free angle shooting

The monitor can be rotated to suit your needs. This is convenient as it allows you to take pictures from various angles by adjusting the monitor.

Taking pictures at high angle

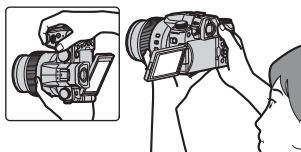

Taking pictures at low angle

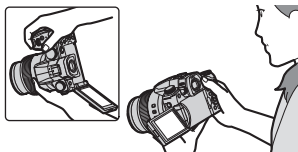

Shutter button (Taking pictures)

1 Set mode dial to [iA]

- The camera automatically optimizes the main settings.
- For details on the recording modes, refer to (→25).

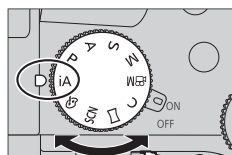

2 Press the shutter button halfway (press lightly) to focus on the subject



- (A) Shutter speed
- (B) Aperture value
- (C) Focus display (Green)
(When focus is aligned: illuminated
When focus is not aligned: flashing)

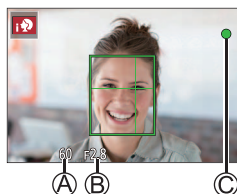

3 Press the shutter button fully (push the button all the way), and take the picture



- Pictures can be taken only when the image is correctly focused as long as the [Focus/Release Priority] is set to [FOCUS].

■ Check the picture you have taken

Press the [▶] (Playback) button. (→56)



Basic operations

Zoom lever (Use zoom)

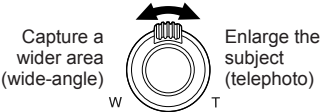
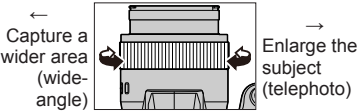
Zoom lever	Control ring*
<p>1 Move the zoom lever</p>  <p>• The zoom speed varies according to how far you rotate the lever.</p>	<p>1 Turn the control ring</p>  <p>* "Control ring" (→26)</p>

Optical Zoom:

You can zoom in without degrading the picture quality.

Maximum magnification: 16x

Extended optical zoom:

This function works when picture sizes with [EX] have been selected in [Picture Size]. Extended optical zoom allows you to zoom in using a higher zoom ratio than optical zoom, without degrading the picture quality.

Maximum magnification: 32x*1

*1 Including the optical zoom ratio. The maximum zoom ratio varies depending on the picture size.

[i.Zoom]:

Set the [i.Zoom] in the [Rec]/[Motion Picture] menu to [ON].

You can use the camera's intelligent resolution technology to increase the zoom ratio up to 2x*2 higher than the original zoom ratio with limited deterioration of picture quality.

*2 Up to 1.5x the original zoom ratio when [Picture Size] is set to [S]

[Digital Zoom]:

Set the [Digital Zoom] in the [Rec]/[Motion Picture] menu to [ON].

You can zoom in up to 4x the original zoom magnification. When [Digital Zoom] is used simultaneously with [i.Zoom], you can increase the combined zoom ratio up to 4x. Note that, with Digital Zoom, enlarging will decrease picture quality.

- When [Monitor Display Speed] is set to [ECO 30fps], Digital Zoom is not available (setting at the time of purchase).
- When [LVF Display Speed] is set to [ECO 30fps], Digital Zoom is not available.

■ [Zoom Compose Assist] button (Using the Zoom Compose Assist function)

If you lose the subject while zoomed in:

- ① Press and hold [- A frame indicating the original zoom magnification (angle of view) will appear.

When you find the subject:

- ② Align the frame with the subject and release your finger from the button





Mode dial (Select the recording mode)

1 Set to the desired recording mode

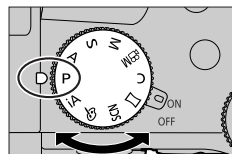



- Rotate the mode dial slowly to select the desired mode.



iA	iA Intelligent Auto Mode (→32)
	iA+ Intelligent Auto Plus Mode (→32)
P	Program AE Mode Take pictures with automatic shutter speed and aperture value settings.
A	Aperture-Priority AE Mode Determine aperture, then take pictures.
S	Shutter-Priority AE Mode Determine shutter speed, then take pictures.
M	Manual Exposure Mode Determine aperture and shutter speed, then take pictures.
 M	Creative Video Mode (→53) Determine aperture, shutter speed and ISO sensitivity, then record motion pictures. • You cannot take still pictures.
C	Custom Mode Take pictures using pre-registered settings.
	Panorama Shot Mode Take panorama pictures.
SCN	Scene Guide Mode Take pictures that match the scene being recorded.
	Creative Control Mode Take pictures by selecting your preferred picture effect.

Control ring

You can use the control ring to change the settings for recording.

Mode dial	Control ring*
iA	
P	
A	
S	
M	
 M	 Step Zoom
	 Picture effects change
SCN	 Step Zoom

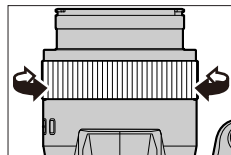

* When Manual Focus is set, the control ring is assigned to focus adjustment.

- You can change to your preferred settings using [Control Ring] from the [Custom] ([Operation]) menu.

Front dial/Rear dial

Rotating:

Selection of items or setting of values is performed during the various settings.

- Ⓐ Front dial
- Ⓑ Rear dial

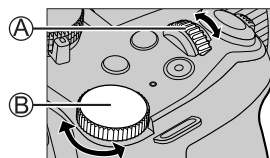

Allows you to set the aperture, shutter speed, and other settings when in [P] / [A] / [S] / [M] modes.

Mode dial	Front dial	Rear dial
P	Program Shift	Program Shift
A	Aperture value	Aperture value
S	Shutter speed	Shutter speed
M	Aperture value	Shutter speed

- This owner's manual describes operations of the front dial/rear dial as follows:

Turn the front dial



Rotate the rear dial



Cursor button / [MENU/SET] button (Selecting/setting items)

Pressing the cursor button:

Selection of items or setting of values etc., is performed.

Pressing [MENU/SET]:

Confirmation of setting contents, etc., is performed.

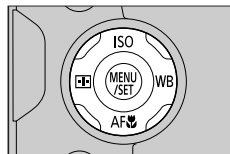

- This owner's manual expresses the up, down, left, and right of the cursor button as ▲▼◀▶.

[DISP.] button (Switching the display information)

1 Press [DISP.] button to switch the display

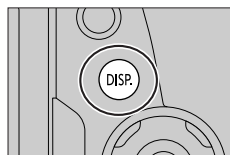

During recording

You can switch the viewfinder/monitor display method.

MENU → **C/F** [Custom] → **i** [Monitor / Display] → [LVF/Monitor Disp. Set]
→ [LVF Disp. Set] or [Monitor Disp. Set]

[] (viewfinder style)

Scales down images slightly so that you can better review the composition of the images.

[] (monitor style)

Scales images to fill the entire screen so that you can see their details.

■ **[]** Live View Finder style display layout (Example of viewfinder style display)

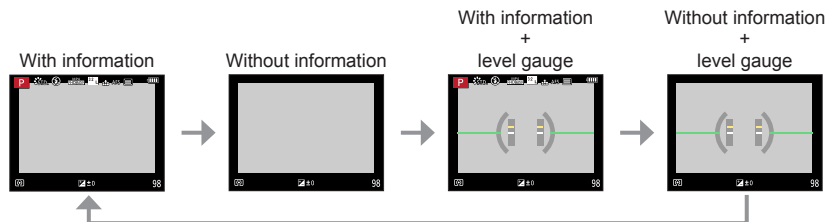

■ [] Monitor style display layout (Example of monitor style display)

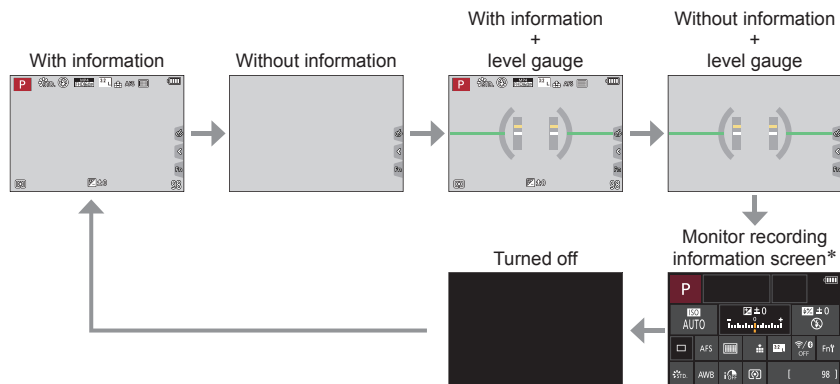

* This screen is displayed only when [Monitor Info. Disp.] in the [Custom] ([Monitor / Display]) menu is set to [ON]. Settings can be adjusted directly by touching each of the items displayed on the screen.

● With [Fn Button Set] in the [Custom] ([Operation]) menu, you can assign [LVF/Monitor Disp. Style] to a function button. Each time you press the assigned function button, the display style of the monitor or viewfinder ([]/[]), whichever is currently in use, will change.

During playback

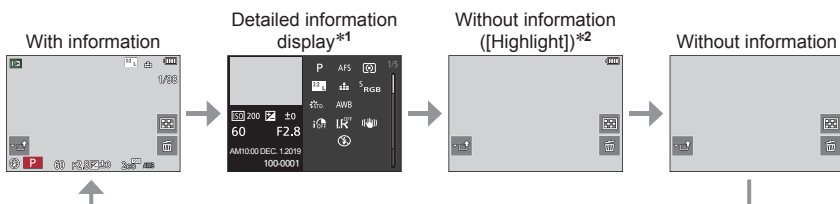

*1 Press ▲▼ to switch between the following display modes:

- Detailed information display
- Histogram display
- Photo style, Highlight shadow display
- White balance display
- Lens information display

*2 This screen is displayed only when [Highlight] in the [Custom] ([Monitor / Display]) menu is set to [ON].

Touch screen (Touch operations)

Touch

To touch and release the touch screen.



Drag

To touch and slide your finger across the touch screen.



Pinch (spread/pinch)

On the touch screen, spread (pinch out) your 2 fingers to zoom in, and pinch (pinch in) your 2 fingers to zoom out.

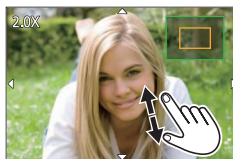

Taking Pictures Using the Touch Function

1 Touch [◀]

2 Touch an icon

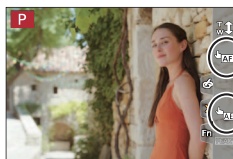

■ Touch AF, Touch Shutter

The icon switches every time you touch it.

[] (Touch AF)	Focuses on the position you touch.
[] (Touch shutter)	Focuses on the touched position before recording takes place.
[] (OFF)	Touch AF and Touch Shutter are disabled.

■ [Touch AE]

You can easily optimize the brightness for a touched position.

[] ([Touch AE])	<ol style="list-style-type: none"> Touch the subject you want to optimize the brightness for Touch [Set] <ul style="list-style-type: none"> To cancel the function, touch [].
-----------------	--

Setting the menu

1 Press [MENU/SET] to bring up the menu

2 Switch the menu type

- ① Press ◀
- ② Press ▲▼ to select a tab such as [🔧]
 - You can also select the menu toggle icons by rotating the front dial.
- ③ Press [MENU/SET]

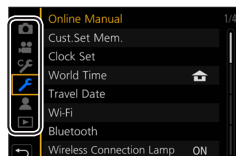

■ Menu types

- [Rec] [Motion Picture]
- [Setup] [My Menu]
- [Custom] [Playback]
- Menus to be displayed in each recording mode (→59)

3 Press ▲▼ to select the menu item and press [MENU/SET]

- The menu item can also be selected by rotating the rear dial.
- You can also switch to the next page by rotating the zoom lever.

4 Press ▲▼ to select the setting and press [MENU/SET]

- The setting can also be selected by rotating the rear dial.
- The setting methods vary depending on the menu item.

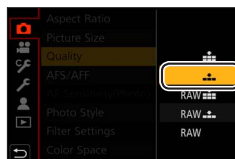

5 Press [↵] button repeatedly until the recording or playback screen reappears

- The menu screen can also be exited by pressing the shutter button halfway.

- You can display an explanation on the menu by pressing the [DISP.] button while you select a menu item or setting.
- The menu items that cannot be set are grayed out. In some setting conditions, the reason the setting is disabled is displayed when you press [MENU/SET] if you select a grayed-out menu item.

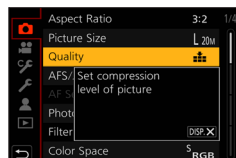

Calling frequently-used menus instantly (Quick Menu)

You can easily call some of the menu items and set them during recording.

- 1 Press [Q.MENU] button
- 2 Rotate the front dial to select a menu item
- 3 Rotate the rear dial to select the setting
- 4 Press [Q.MENU] button to close the Quick menu



Assigning frequently used functions to the buttons (Function buttons)

You can assign frequently-used functions to particular buttons ([Fn1] - [Fn8]) or icons displayed on the screen ([Fn9] - [Fn13]).

- 1 Set the menu

MENU → [Custom] → [Operation] → [Fn Button Set]

Settings: [Setting in REC mode] / [Setting in PLAY mode]

- 2 Press ▲ ▼ to select the function button you want to assign a function to and press [MENU/SET]
 - You can press [DISP.] button to switch pages.
- 3 Press ▲ ▼ to select the function you want to assign and press [MENU/SET]

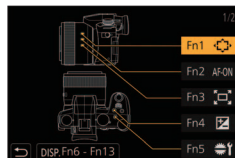

- The screen displayed in Step 3 can be displayed by holding a function button ([Fn1] to [Fn8]) for 2 seconds.
- Certain functions cannot be assigned to some function buttons.

Taking pictures with automatic settings

(Intelligent Auto Mode)

This mode is recommended for those who want to point and shoot as the camera optimizes settings to match the subject and recording environment.

1 Set mode dial to [iA]

- At the time of purchase, the mode is set to Intelligent Auto Plus Mode.

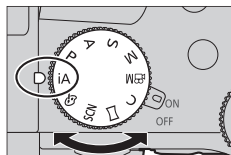

2 Point the camera at the subject

- When the camera identifies the optimal scene, the icon switches to the one for that scene. (Automatic Scene Detection)



■ Switching between Intelligent Auto Plus Mode and Intelligent Auto Mode

MENU → **iA** / **iA+** [Intelligent Auto] → [Intelligent Auto Mode]

Settings: [iA] (Intelligent Auto Mode) / [iA+] (Intelligent Auto Plus Mode)

- [iA+] allows you to adjust some settings such as the brightness and color tone while also using [iA] for other settings so that you can record pictures more suited to your preferences. (→33)
- When [iHandheld Night Shot] is set to [ON] and [iA+] is detected while taking handheld night shots, pictures of the night scenery will be taken at a high burst speed and composed into a single picture.
- When [iHDR] is set to [ON] and there is, for example, strong contrast between the background and the subject, multiple still pictures are recorded with differing exposures and combined to create a single still picture rich in gradation.

■ Auto Focus (Face/Eye Detection)

[AF Mode] is automatically set to [iAF]. If you touch the subject, the camera switches to [iAF] and the AF tracking function starts operating.

- You can also switch to [iAF] by pressing [iAF] button (◀). Align the AF tracking area with the subject and press the shutter button halfway to operate the AF tracking function.

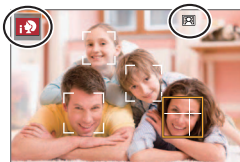

Taking pictures with customized coloring, blurriness of the background and brightness

Recording mode: 

■ Setting coloring

- ① Press [WB] button (▶) to display the setting screen
- ② Rotate the rear dial to adjust color
 - Press [MENU/SET] to return to the recording screen.





■ Defocusing the background (Defocus control function)

- ① Press [Fn7] button to display the setting screen
- ② Rotate the rear dial to set the blurriness of the background
 - Press [MENU/SET] to return to the recording screen.
 - Pressing [Fn7] button on the setting screen will cancel the setting.





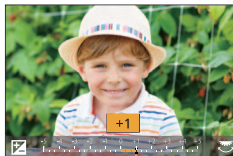

■ Setting brightness

- ① Press [] button
- ② Rotate the rear dial to compensate the brightness
 - You can change the setting content on the exposure compensation screen from [Exposure Comp. Disp. Setting] in the [Custom] ([Operation]) menu.
 - Press [] button again to return to the recording screen.



■ With touch screen operations

- ① Touch []
- ② Touch the item you want to set
 - []: Coloring / []: Degree of defocusing / []: Brightness
- ③ Drag the slide bar or exposure meter to set
 - Press [MENU/SET] to return to the recording screen.



Taking pictures with Auto Focus

Recording mode: **P** **A** **S** **M**

Set the focusing operation to be performed when the shutter button is pressed halfway.

1 Set the focus mode lever to **[AFS/AFF]** or **[AFC]**

- It is fixed to [AFS] when Panorama Shot Mode is set.

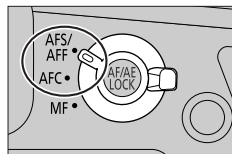

Settings	The movement of the subject and the scene
[AFS/AFF]	[AFS] (Auto Focus Single) Subject is still (Scenery, anniversary photograph, etc.) Focus is set automatically when the shutter button is pressed halfway. Focus will be fixed while it is pressed halfway.
	[AFF] (Auto Focus Flexible) Movement cannot be predicted (Children, pets, etc.) If the subject moves while the shutter button is pressed halfway, the focus is corrected to match the movement automatically.* You can switch the setting with [AFS/AFF] in the [Rec]/[Motion Picture] menu.
[AFC] (Auto Focus Continuous)	Subject is moving (Sport, trains, etc.) While the shutter button is pressed halfway, focusing is constantly performed to match the movement of the subject.*

* When the subject is moving, the focusing is performed by predicting the subject position at the time of recording. (Movement prediction)

■ Setting the tracking sensitivity of the focus position

Recording mode: **P** **A** **S** **M**

This item works only when the Focus Mode is set to [AFF] or [AFC].

MENU → **[Rec]** → **[AF Sensitivity(Photo)]**

Settings: [-2] to [+2]

+	When the distance to the subject changes drastically, the camera re-adjusts the focus immediately. You can bring different subjects into focus one after another.
-	When the distance to the subject changes drastically, the camera waits for a short period of time before re-adjusting the focus. This allows you to prevent the focus from being accidentally re-adjusted when, for example, an object crosses the camera.

Switching [AF Mode]

Recording mode: **PAS**

This allows the focusing method that suits the positions and number of the subjects to be selected.

1 Press [**AF**] button (◀)

2 Press ◀▶ to select Auto Focus mode and press [MENU/SET]

Settings: [] (Face/Eye Detection) / [] (Tracking) / [] (49-area-focusing) / [] etc. (Custom Multi) / [] (1-area-focusing) / [] (Pinpoint-focusing)

Taking close-up pictures (Macro recording)

Recording mode: **PAS**

This mode allows you to take close-up pictures of a subject, e.g. when taking pictures of flowers.

1 Press [AF] button (▼)

2 Press ◀▶ to select the item and press [MENU/SET]

[AF] ([AF Macro])	You can take pictures of a subject as close as 3 cm (0.098 feet) from the lens by rotating the zoom lever upmost to Wide.
[] ([Macro Zoom])	Use this setting to get close to the subject and then further enlarge when taking the picture. You can take a picture with the Digital Zoom up to 3x while maintaining the distance to the subject for the extreme Wide position (3 cm (0.098 feet)). • Note that enlarging will decrease picture quality. • Zoom range will be displayed in blue (digital zoom range).

- You may be unable to select the items, depending on the recording mode and other settings.

Taking pictures with Manual Focus

Recording mode: 

Manual Focus is convenient when you want to lock the focus to take pictures or when it is difficult to adjust focus using Auto Focus.

1 Set the focus mode lever to [MF]

2 Press  button (◀)

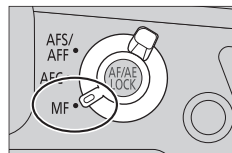

3 Press ▲▼◀▶ to adjust the focus position, and press [MENU/SET]

- The screen changes to the assist screen and an enlarged display appears. (MF Assist)
- To return the focus position to the center, press [DISP.] button.

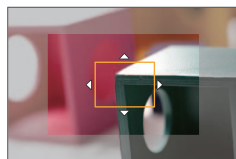

4 Turn the control ring to adjust focus

Rotate to **A side:** Focuses on nearby subject

Rotate to **B side:** Focuses on faraway subject

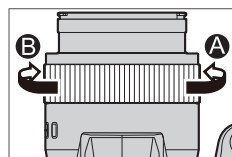

- Color is added to the portions of the image that are in focus. (Peaking)
- You can check whether the point of focus is to the near side or to the far side. (MF Guide)

A MF Assist (Enlarged screen)

B Peaking

C MF Guide

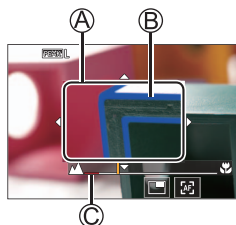

5 Press the shutter button halfway

- The recording screen will be displayed.

Focus, Brightness (Exposure) and Color tone Settings

Taking pictures by locking the focus and/or exposure (AF/AE Lock)

Recording mode: **P** **A** **S** **M**

You can use the AF/AE Lock function to fix the focus and exposure in advance and change the composition of the picture when recording. This function is convenient when you want to focus on the edge of the screen or when your subject is back-lit.

1 Point the camera at the subject

2 Lock the focus and/or exposure while you press and hold [AF/AE LOCK] button

- When you release [AF/AE LOCK] button, the focus and/or exposure lock is canceled.

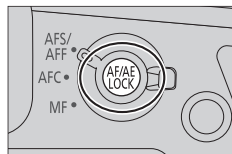

3 While you press and hold [AF/AE LOCK] button, move the camera to compose the picture you want to take and fully press the shutter button

■ Setting the function of [AF/AE LOCK]

MENU → [Custom] → [Focus / Release Shutter] → [AF/AE Lock]

Taking pictures with Exposure Compensation

Recording mode: **P** **A** **S** **M**

Corrects the exposure when there is a backlight or when the subject is too dark or too bright.

1 Press [] button

2 Rotate the rear or front dial to compensate the exposure

Exposure Compensation

- You can change the setting content on the exposure compensation screen from [Exposure Comp. Disp. Setting] in the [Custom] ([Operation]) menu.

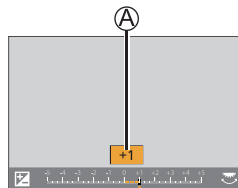

3 Press [] to set

- You can also press the shutter button halfway to set.

- In Manual Exposure Mode, you can correct the exposure only when the ISO sensitivity is set to [AUTO].

Setting the ISO Sensitivity

Recording mode: **PAS**

Set ISO sensitivity (sensitivity to lighting).

1 Press [ISO] button (▲)

2 Select the ISO sensitivity by rotating the rear or front dial

ISO sensitivity

- You can change the setting content on the ISO sensitivity screen from [ISO Displayed Setting] in the [Custom] ([Operation]) menu.

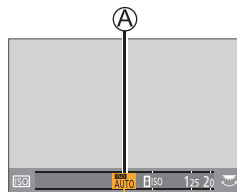

AUTO	ISO sensitivity is automatically set in a range up to 3200* ¹ depending on the brightness of a subject.
ISO (Intelligent ISO)	ISO sensitivity is automatically set in a range up to 3200* ¹ depending on the movement and brightness of a subject.
[L.80]*² / [L.100]*² / from [125] to [12800] / [H.25600]*²	ISO sensitivity is fixed at the selected setting.

*¹ When [ISO Auto Upper Limit (Photo)] in the [Rec] menu is set to [AUTO].

*² Only when [Extended ISO] in the [Custom] ([Exposure]) menu is [ON].

3 Press [MENU/SET] to set

- You can also press the shutter button halfway to set.
- Cannot select [ISO] in the following cases:
 - Shutter-Priority AE Mode
 - Manual Exposure Mode
- You can use the following ISO sensitivity settings when recording in Creative Video Mode, when recording 4K photos, or when recording using [Post Focus].
 - [AUTO], [125] to [6400] ([L.80] to [6400] when [Extended ISO] is set to [ON])

Adjusting the White Balance

Recording mode: **PAS**

This item adjusts to the color of white which is closest to what is seen by the eye in accordance with the light source.

1 Press [WB] button (▶)

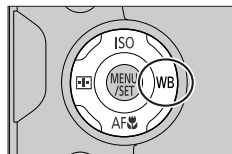

2 Rotate the rear or front dial to select the White Balance

[AWB]/ [AWBc]/ [AWBw]	Automatic adjustment in accordance with the light source. <ul style="list-style-type: none"> Under a light source (such as an incandescent light) that produces reddish pictures: <ul style="list-style-type: none"> [AWBc] gives higher priority to the original colors of the subject and reduces the reddish hue. [AWBw] gives higher priority to what is seen by the eye and retains the reddish hue. When the white balance is set to [AWBc] or [AWBw], the adjustment effect may be similar to that of [AWB], depending on the light source.
	Adjust to the color under a clear sky.
	Adjust to the color under a cloudy sky.
	Adjust to the color in the shade.
	Adjust to the color under incandescent lights.
	Adjust to the color that is optimal for taking pictures using the flash.
 	Use the White Balance value that was set manually.
	You can set the White Balance using color temperature.

* The [AWB] setting is applied while recording motion pictures, recording 4K photos, or recording in [Post Focus].

3 Press [MENU/SET] to set

- You can also press the shutter button halfway to set.

■ Performing White Balance fine adjustments

White Balance settings can be individually fine-tuned if colors still do not appear as anticipated.

- ① In step **2** of “Adjusting the White Balance” (→39), select the White Balance and press ▼
- ② Use ▲▼◀▶ to perform White Balance fine adjustments
 - Pressing [DISP.] button resets the position back to the center.
- ③ Press [MENU/SET] to finalize the setting
 - Press the shutter button halfway to return to the recording screen.

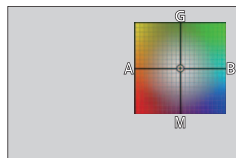

■ Bracket recording using White Balance

Bracket settings are performed based on the fine adjustment values for White Balance, and three pictures with different coloring are automatically recorded when the shutter button is pressed once.

- ① Perform fine adjustments of the White Balance in step ② of “Performing White Balance fine adjustments” (above) and rotate the rear dial to perform the Bracket setting
- ② Press [MENU/SET] to finalize the setting
 - Press the shutter button halfway to return to the recording screen.

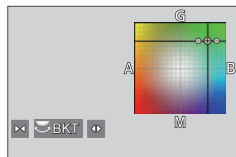

Selecting a Drive Mode ([Burst] / [Self Timer])

Recording mode: **PAS**

You can switch the operation to be performed when you press the shutter button.

1 Rotating the drive mode dial

[Single]	When the shutter button is pressed, only one picture is recorded.
[Burst]	The pictures are recorded in succession while the shutter button is pressed.
[4K PHOTO] (→42) / [Post Focus] (→45) / [Time Lapse/Animation] (→47)	
[Self Timer]	When the shutter button is pressed, recording takes place after the set time has elapsed.

Burst function

■ Setting [Burst Rate]

MENU → [Rec] → [Burst Rate]

		[H] (High speed)	[M] (Middle speed)	[L] (Low speed)
Speed (pictures/sec.)	[AFS] / [MF]	12	7	2
	[AFF] / [AFC]	7		
Live View during burst recording	[AFS] / [MF]	None	Available	Available
	[AFF] / [AFC]	Available		
Number of recordable pictures	With RAW files	26 or more		
	Without RAW files	100 or more		

Taking pictures with self-timer

■ Setting the self-timer operation

MENU → [Rec] → [Self Timer]

	The shutter is activated after 10 seconds.
	The shutter is activated after 10 seconds and three pictures are taken at intervals of approximately 2 seconds.
	The shutter is activated after 2 seconds.

Recording with the 4K Photo function

Recording mode:

You can take burst pictures of approximately 8 million pixels with a burst rate of 30 fps. You can select and save a frame from the burst file.

- To record pictures, use a UHS Speed Class 3 card.
- When recording, the angle of view becomes narrower.

1 Set the drive mode dial to

2 Select the recording method

MENU → [Rec] → [4K PHOTO]

[4K Burst]

For capturing the best shot of a fast-moving subject

Burst recording is performed while the shutter button is pressed and held.

- Recording will start approximately 0.5 seconds after you press the shutter button fully. Therefore, press the button fully slightly in advance.

- (A) Press and hold
- (B) Recording is performed

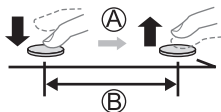

[4K Burst(S/S)]

"S/S" is an abbreviation of "Start/Stop".

For capturing unpredictable photo opportunities

Burst recording starts when the shutter button is pressed and stops when pressed again.

- (C) Start (First)
- (D) Stop (Second)
- (E) Recording is performed

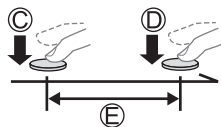

- When you press the [Fn6] button while recording, you can add a marker. (Up to 40 markers for each recording.) When selecting and saving pictures from a 4K burst file, you can skip to the positions where you added markers.

[4K Pre-Burst]

For recording as needed whenever a photo opportunity arises

Burst recording is performed for approximately 1 second before and after the moment that the shutter button is pressed.

- (F) Approximately 1 second
- (G) Recording is performed

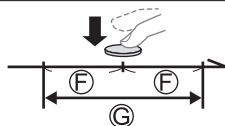

3 Press the shutter button halfway to exit the menu

4 Press the shutter button to perform recording

- Burst pictures are saved as a single 4K burst file in the MP4 format.
 - When [Auto Review] is enabled, the picture selection screen will be displayed automatically.
- If the surrounding temperature is high or 4K photos are recorded continuously, [△] may be displayed and recording may be stopped halfway through. Wait until the camera cools down.
 - When [4K Pre-Burst] is set, the battery drains faster and the camera temperature rises. (to protect itself, the camera may switch to [4K Burst])
Select [4K Pre-Burst] only when recording.
 - Recording stops when the continuous recording time exceeds 29 minutes and 59 seconds.
When using an SDHC memory card, files are split into smaller picture files for recording and playback if the file size exceeds 4 GB. (You can continue to record pictures without interruption.)
If using an SDXC memory card, you can record pictures in a single file even if the size is greater than 4 GB.
 - When you perform [Light Composition] or [Sequence Composition], we recommend using a tripod and shutter remote control (DMW-RS2, optional) to prevent camera shake. (→12)

Selecting pictures from 4K burst file and saving

1 Select a picture with the [4K] on the playback screen, and press ▲

- In the case of recording with [4K Pre-Burst], proceed to the step 3.



2 Drag the slide bar to perform rough scene selection

- When [Fn6] is touched, the marker operation screen appears. (→44)

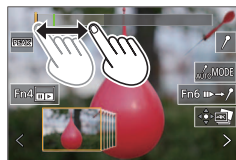

3 Drag to select the frame you want to save as a picture

- To continuously rewind/forward the scene or frame-by-frame, touch and hold [<]/[>].



4 Touch [] to save the picture

- The selected picture will be saved as a new picture in the JPEG format separate from the 4K burst file.
- If you use [4K PHOTO Bulk Saving] in the [Playback] menu, you can bulk save 5 seconds' worth of 4K recording.

■ Marker

When selecting and saving pictures from a 4K burst file, you can select pictures easily by skipping between marked positions.

White marker: This is manually set during recording or playback.

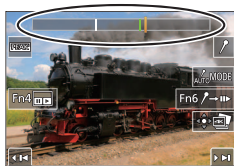

Green marker: This is automatically set by the camera during recording. (Auto Marking function*1)

- *1 The camera automatically sets markers on scenes in which a face or the movement of a subject is detected. (Up to 10 markers are displayed for each file.)
(Example: At the scene when a vehicle passes by, a balloon bursts, or a person turns around)



Marker operation screen

■ Skips to the marked positions

When [→] is touched, the marker operation screen appears. You can use ▶ to skip to a marked position to select a picture.

Touch [→] to return to the original operation.

- In the following cases, markers may not be set by the Auto Marking function depending on the recording conditions and the status of subjects.
 - The camera is moving because of panning or jitter
 - The movement of a subject is slow/small, or the subject is small
 - A face is not facing front

■ Switches a marker to be displayed

- ① Touch []

Settings: [Auto] / [Face Priority] / [Motion Priority] / [Off]*2

*2 Displays manually set markers only

Adjusting the focus after recording

([Post Focus] / [Focus Stacking])

Recording mode:        

You can record 4K burst pictures while changing the focus point and then select a focus point after recording. This function is best for non-moving subjects.

- To record pictures, use a UHS Speed Class 3 card.
- We recommend using a tripod to perform [Focus Stacking].
- During recording, the angle of view will be narrower.

1 Set the drive mode dial to

2 Determine the composition and press the shutter button halfway

- Auto Focus activates and automatically detects the focus point on the screen. (While the shutter button pressed halfway, shake may be seen on the screen.)
- If there is no focus point on the screen, the Focus indicator (A) blinks and you cannot record.



From halfway pressing the shutter button to completion of recording

- Do not change the distance to subject or the composition.

3 Press the shutter button fully to start recording

- The focus point changes automatically while recording. When the recording progress bar (B) disappears, recording automatically ends.
- The data will be saved as a single file in the MP4 format.
- If [Auto Review] is set, a screen will automatically appear that lets you select the focus point. (→45)

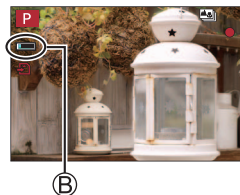

- If the surrounding temperature is high or [Post Focus] recording is performed continuously, [A] may be displayed and recording may be stopped halfway through. Wait until the camera cools down.

Select the focus point and save the picture ([Post Focus])

1 On the playback screen, select the image with the icon and press ▲



2 Touch the focus point

- If there are no pictures with the focus on the selected point, a red frame will be displayed, and pictures cannot be saved.
- The edge of the screen cannot be selected.
- To switch to the [Focus Stacking] operations screen, touch [Focus Stacking].
- To highlight in-focus portion with color, touch [PEAK].
- To enlarge the display, touch [Q].



- You can make fine adjustments to the focus by dragging the slide bar during enlarged display. (The same operation can be performed using ◀▶.)

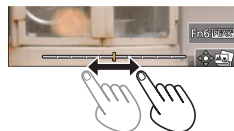

3 Touch [Focus Stacking] to save the picture

- The selected picture will be saved as a new separate file in the JPEG format.

Select the focus range to combine and create a single picture ([Focus Stacking])

1 Touch [Focus Stacking] on screen in step 2 of “Select the focus point and save the picture ([Post Focus])”

2 Choose a stacking method and touch it

[Auto Merging]	Automatically select photos suitable for stacking and combine them into one picture. <ul style="list-style-type: none"> • Choose by giving preference to near-focus pictures. • Perform the focus stacking and save the picture.
[Range Merging]	Combine the pictures with the selected focus position into one picture.

(When selecting [Range Merging])

3 Touch the focus point

- Select positions at two or more points.
- Focus points between the selected two positions will be selected.
- Positions that cannot be selected, or that would produce an unnatural result will be grayed out.

- Touch a position again to deselect it.

4 Touch [Focus Stacking] to combine and save the picture

- The picture will be saved in JPEG format.

- Only pictures taken using [Post Focus] on this camera are eligible for [Focus Stacking].

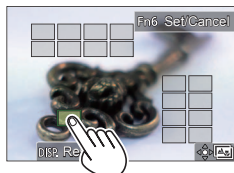

Taking Pictures with Time Lapse Shot/Stop Motion Animation

Recording mode:   **PASM**   

You can take pictures with Time Lapse Shot or Stop Motion Animation.

- The pictures are recorded as a set of group pictures.
- **Complete the date and time settings in advance. (→21)**

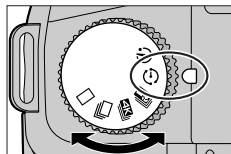

Taking pictures automatically at set intervals [Time Lapse Shot]

The camera can automatically take pictures of subjects such as animals or plants as time elapses and create a motion picture.

- 1 Set the drive mode dial to []
- 2 Set the menu

MENU →  **[Rec]** → **[Time Lapse/Animation]**

[Mode]	To switch between Time Lapse Shot and Stop Motion Animation ① Select [Time Lapse Shot]	
[Shooting Interval Setting]	[ON]: Sets the time from recording start time to the next recording start time. [OFF]: After recording is finished, the next recording is started without any interval.	
[Start Time]	[Now]	Starts the recording by fully-pressing the shutter button.
	[Start Time Set]	① Press ◀▶ to select the item (hour and/or minute), and ▲▼ to set the start time, and press [MENU/SET]
[Image Count] / [Shooting Interval]*	◀▶ : Select the item (digit) / ▲▼ : Setting / [MENU/SET]: Set	

* Can be set only when [Shooting Interval Setting] is set to [ON].

- 3 Press the shutter button halfway to exit the menu
- 4 Focus on the subject and take a picture
 - The recording starts by fully-pressing the shutter button.

- After recording is finished, a confirmation screen will appear asking whether you want to continue and create a motion picture. To create a motion picture, select [Yes] and proceed to “Creating motion pictures from recorded pictures” (→48).

Creating stop motion animation [Stop Motion Animation]

You can stitch still pictures to create stop motion animation.

1 Set the drive mode dial to [**(↓)**]

2 Set the menu

[MENU] →  [Rec] → [Time Lapse/Animation]	
[Mode]	To switch between Time Lapse Shot and Stop Motion Animation ① Select [Stop Motion Animation]
[Auto Shooting]	[ON]: Takes pictures automatically at a set recording interval. [OFF]: Takes pictures manually, one frame at a time.
[Shooting Interval]	[Only when [Auto Shooting] is set to [ON]] Set the interval used for [Auto Shooting].

3 Press the shutter button halfway to exit the menu

4 Focus on the subject and take a picture

5 Move the subject to decide on the composition

- Repeat the recording of still pictures in the same way. Up to 9,999 frames can be recorded.
- When you turn off the camera during recording, a message to restart recording will appear when you turn on the camera.

6 Touch [] to end the recording

- You can also end the recording by selecting [Time Lapse/Animation] in the [Rec] menu, and then pressing [MENU/SET].
- When [Auto Shooting] is set to [ON], select [End] on the confirmation screen. (If you select [Pause], press the shutter button fully to resume recording.)



Creating motion pictures from recorded pictures

To create motion pictures after taking pictures, follow the steps below.

1 Select the motion picture creation method

- [Rec Format]: [MP4]

[Rec Quality]	Sets the picture quality of the motion picture.
[Frame Rate]	Set the number of frames per second. The higher the number is, the smoother the motion picture will be.
[Sequence]	[NORMAL]: Stitches the still pictures in the recording sequence. [REVERSE]: Stitches the still pictures in the reverse order of recording.

2 Press **▲** to select [OK] and press [MENU/SET]

- You can also create a motion picture using [Time Lapse Video]/[Stop Motion Video] in the [Playback] menu.

Taking Pictures While Adjusting a Setting Automatically

(Bracket Recording)

Recording mode: **P** **A** **S** **M**

You can take multiple pictures while automatically adjusting a setting by pressing the shutter button.

1 Set the menu

MENU → **[Rec]** → **[Bracket]** → **[Bracket Type]**

(Exposure Bracket)	Press the shutter button to perform recording while adjusting the exposure. (→50)
(Aperture Bracket)	Press the shutter button to perform recording while adjusting the aperture. (→50) • Available in Aperture-Priority AE Mode or when the ISO sensitivity is set to [AUTO] in Manual Exposure Mode.
FOCUS (Focus Bracket)	Press the shutter button to perform recording while adjusting the focus position. (→50)
WB (White Balance Bracket)	Press the shutter button once to take three pictures with different white balance settings automatically. (→40)

2 Press ▼ to select [More Settings] and then press [MENU/SET]

- For information on [More Settings], refer to the page that describes each function.
- Press the shutter button halfway to exit the menu.

3 Focus on the subject and take a picture

- When Exposure Bracket is selected, the bracket display flashes until all of the pictures you have set are taken. If you change the bracket settings or turn off the camera before all of the pictures you have set are taken, the camera restarts recording from the first picture.

■ To cancel [Bracket]

Select [OFF] in step 1.

Exposure Bracket

■ About [More Settings] (step 2 in (→49))

[Step]	Sets the number of pictures to be taken and the exposure compensation range. [3•1/3] (Takes three pictures with an interval of 1/3 EV) to [7• 1] (Takes seven pictures with an interval of 1 EV)
[Sequence]	Sets the order in which pictures are taken.
[Single Shot Setting]*	[□]: Takes one picture each time you press the shutter button. [☐]: Takes all the pictures set to be taken when you press the shutter button once.

* Not available for burst recording. When using burst recording, if you press and hold the shutter button, recording will be performed continuously until a specified number of pictures are taken.

- When taking pictures using Exposure Bracket after setting the Exposure Compensation value, the pictures taken are based on the selected Exposure Compensation value.

Aperture Bracket

Recording mode: **A****M**

■ About [More Settings] (step 2 in (→49))

[Image Count]	[3]/[5]: Takes a specified number of pictures with different aperture values within the range based on the initial aperture value. [ALL]: Takes pictures using all aperture values.
---------------	--

- When using burst recording, if you press and hold the shutter button, recording will be performed until a specified number of pictures are taken.

Focus Bracket

■ About [More Settings] (step 2 in (→49))

[Step]	Sets the interval between focus positions.
[Image Count]*	Sets the number of pictures to be taken.
[Sequence]	[0/-/+]: Takes pictures with different focus positions within the range based on the initial focus position. [0/+]: Takes pictures with different focus positions toward the far side based on the initial focus position.

* Not available for burst recording. When using burst recording, if you press and hold the shutter button, recording will be performed continuously until a specified number of pictures are taken.

- Pictures taken with Focus Bracket are displayed as a set of group pictures.

Taking pictures with flash

Recording mode: **P** **A** **S** **M**

■ Open/Close the built-in flash

A To open the flash

Slide the flash open lever.

- Be careful when opening the flash as the flash will jump out.

B To close the flash

Press the flash until it clicks.

- Be careful not to catch a finger or any other part of your body or any object when you close the flash.
- Forcibly closing the flash can damage the camera.
- Be sure to close the built-in flash when not in use.
- The flash setting is fixed to (Forced Flash Off) while the flash is closed.

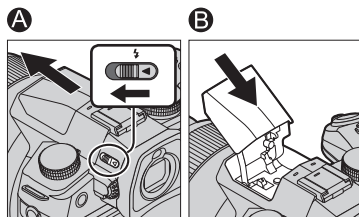

Changing Flash Mode

Recording mode: **P** **A** **S** **M**

Set the flash to match the recording.

MENU → **[Rec]** → **[Flash]** → **[Flash Mode]**

: [Forced Flash On]	The flash is activated every time regardless of the recording conditions. • Use this when your subject is back-lit or under fluorescent light.
: [Forced On/Red-Eye]	
S : [Slow Sync.]	Takes brighter pictures such as pictures of subjects against a nightscape by decreasing the shutter speed when firing a flash. • Ideal for taking pictures of people against a nightscape. • Using a slower speed can cause motion blur. We recommend using a tripod.
S : [Slow Sync./Red-Eye]	
: Forced Flash Off	Always takes pictures without flash under all recording conditions. • Ideal for taking pictures where the use of flash is prohibited.

- In Intelligent Auto Plus Mode, the setting items are and .

The flash is activated twice. The interval between the first and second flash is longer when or is set. The subject should not move until the second flash is activated.

Recording Motion Picture/4K Motion Picture

Recording mode: 

You can record full high-definition quality images that comply with the AVCHD standard, as well as motion pictures or 4K motion pictures recorded in MP4.

1 Press the motion picture button to start recording

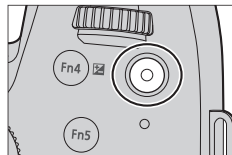

- (A) Elapsed recording time
- (B) Remaining recording time
- (C) Recording (lights up in red)

- Recording of motion picture appropriate for each motion picture mode is possible.
- Immediately release the motion picture button after pressing it.
- If you press the shutter button down fully, you can take still pictures while recording motion pictures. (Except for in Creative Video Mode)

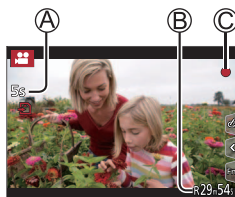

2 Press the motion picture button again to end recording

- To record 4K motion pictures, use a UHS Speed Class 3 card.
- When you record 4K motion pictures, the angle of view will be narrower than motion pictures of other sizes.
- To ensure highly accurate focus, 4K motion pictures are recorded at reduced Auto Focus speeds. It may be difficult to focus on the subject with Auto Focus, but this is not a malfunction.
- **With recording in a quiet environment, the sound of aperture, focus and other actions may be recorded in motion pictures. This is not a malfunction.**
The focus operation during recording of motion pictures can be set to [OFF] in [Continuous AF].
- If the surrounding temperature is high, or a motion picture is recorded continuously, [△] is displayed and recording may be stopped halfway through. Wait until the camera cools down.

■ Setting the format, picture size and recording frame rate

MENU →  **[Motion Picture]** → **[Rec Format]**

Settings: **[AVCHD]** / **[MP4]**

MENU →  **[Motion Picture]** → **[Rec Quality]**

When **[AVCHD]** is selected:

[FHD/28M/60p]*1 / **[FHD/17M/60i]** / **[FHD/24M/30p]** / **[FHD/24M/24p]**

● **[AVCHD]** motion pictures:

- Files are split into smaller motion picture files for recording when the file size exceeds 4 GB.
- Motion pictures with **[Rec Quality]** setting of **[FHD/28M/60p]/[FHD/17M/60i]** in **[AVCHD]**:
Recording stops when the continuous recording time exceeds 29 minutes and 59 seconds.

When **[MP4]** is selected:

[4K/100M/30p]*2 / **[4K/100M/24p]*2** / **[FHD/28M/60p]** / **[FHD/20M/30p]** / **[HD/10M/30p]**

● **[MP4]** motion pictures with a **[Rec Quality]** size of **[FHD]** or **[HD]**:

Files are split into smaller motion picture files for recording and playback when the file size exceeds 4 GB. (You can continue to record motion pictures without interruption.)

● Motion pictures with **[Rec Quality]** setting of **[FHD/28M/60p]** in **[MP4]**:

Recording stops when the continuous recording time exceeds 29 minutes and 59 seconds.

● **[MP4]** motion pictures with a **[Rec Quality]** size of **[4K]**:

Recording stops when the continuous recording time exceeds 29 minutes and 59 seconds.

When using an SDHC memory card, files are split into smaller motion picture files for recording and playback if the file size exceeds 4 GB. (You can continue to record motion pictures without interruption.)

If using an SDXC memory card, you can record a motion picture in a single file even if the size is greater than 4 GB.

*1 AVCHD Progressive

*2 4K motion pictures

Recording Motion Pictures in Creative Video Mode

Recording mode: 

The operation for changing the aperture value, shutter speed or ISO sensitivity is the same as the operation for setting the mode dial to **[P]**, **[A]**, **[S]** or **[M]** (except Program Shift Mode).

1 Set mode dial to 







2 Set the menu

MENU →  **[Creative Video]** → **[Exposure Mode]**

Settings: **[P]** / **[A]** / **[S]** / **[M]**

3 Press the motion picture button (or shutter button) to start recording

- ① Touch  (Cannot be used during [High Speed Video] recording.)
- ② Touch icon

	Zoom		Exposure Compensation
	Aperture value		ISO sensitivity
	Shutter speed		[Sound Rec Level Adj.]

- ③ Drag the slide bar to set

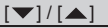
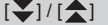
	Changes the setting slowly
	Changes the setting quickly

Using touch icons allows silent operation while recording motion pictures.



4 Press the motion picture button (or shutter button) to stop recording

- The ISO sensitivity can be set within the following range.
 - [AUTO], [125] to [6400] ([L.80] to [6400] when [Extended ISO] is set to [ON])

[4K Live Cropping]

By cropping your motion picture down from the 4K angle of view to Full High Definition, you can record a motion picture that pans and zooms in/out while leaving the camera in a fixed position.

- Hold the camera firmly in place while recording.
- A motion picture will be recorded at [FHD/20M/30p] under [MP4].
- The angle of view narrows.



Pan



Zoom in

1 Set mode dial to [M]**2 Set the menu**

MENU → **M [Creative Video]** → **[4K Live Cropping]**

Settings: [40SEC] / [20SEC] / [OFF]

3 Set the crop start frame and press [MENU/SET] to set

- Set the crop end frame as well.
- When making settings for the first time, a crop start frame of size 1920×1080 is displayed.
- Move the frame by touching it or using the cursor button. You can adjust the frame size by pinching out/pinching in or rotating the rear or front dial.

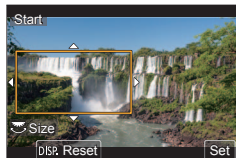
**4 Press the motion picture button (or the shutter button) to start recording**

- Ⓐ Elapsed recording time
- Ⓑ Set operating time

- Immediately release the motion picture button (or the shutter button) after pressing it.
- When the set operating time has elapsed, recording automatically ends. To end recording midway, press the motion picture button (or the shutter button) again.

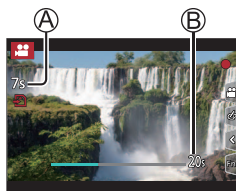

- When you want to zoom in/out, set different angles of view for the cropping start and end frames. For example, to zoom in, set a larger angle of view for the start frame and a smaller angle of view for the end frame.

■ Changing the position and size of a crop frame

Press [Fn7] button while the recording screen is displayed, and perform step 3.

■ To cancel [4K Live Cropping] recording

Set [OFF] in step 2.

- [4K Live Cropping] recording cannot be performed when [High Speed Video] is set.
- Focus is adjusted and fixed in the crop start frame.
- [Continuous AF] is set to [OFF].
- [Metering Mode] will be [M] (Multi Metering).
- You cannot zoom in/out during [4K Live Cropping] recording.

Viewing your pictures

1 Press [▶] (Playback) button

2 Press ◀▶ to select a picture to be displayed

- When you press and hold ◀▶, the pictures are displayed one after another.

■ Ending Playback

Press [▶] (Playback) button again or press the shutter button halfway.

- The playback screen appears if the camera is turned on while pressing [▶] (Playback) button.
- When [Lens Retraction] is set to [ON], the lens barrel is retracted after approx. 15 seconds as the camera is switched to the playback screen from the recording screen.

Viewing motion pictures

This unit was designed to play motion pictures using the AVCHD and MP4 formats.

- Motion pictures are displayed with the motion picture icon ([▶]).

1 Press ▲ to start playback

- Touching [▶] in the middle of the screen allows you to play back motion pictures.



■ Operations during motion picture playback

Operation	Touch operation	Description
▲	[▶/]	Play / pause
◀	[◀◀]	Fast rewind*1
	[◀]	Single-frame rewind*2 (while paused)
▶	[▶▶]	Fast forward*1
	[▶]	Single-frame forward (while paused)
▼	[■]	Stop
	[−] / [+]	Volume down / Volume up

*1 The fast forward or rewind speed increases if you press ◀▶ again.

*2 Motion pictures recorded in [AVCHD] are rewound frame by frame approximately every 0.5 seconds.

- If you press [MENU/SET] during a pause, you can create a picture from a motion picture.

Switching the Playback Method

Zooming in and viewing “Playback Zoom”

1 Move the zoom lever toward T side

1x → 2x → 4x → 8x → 16x

Operation	Touch operation	Description
—	Pinch out / Pinch in	Enlarges/reduces the screen in small steps.
▲▼◀▶	Drag	Moves the enlarged area (during enlarged display).
	—	Forwards/rewinds a picture while maintaining the same zoom magnification and zoom position (during enlarged display).

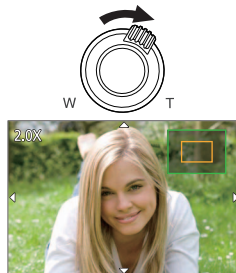

- Pictures recorded with [Quality] set to [RAW] can be enlarged up to 8x.

“Multi Playback”/“Calendar Playback”

1 Move the zoom lever toward W side

1-picture screen (full-screen) → 12-picture screen → 30-picture screen → Calendar screen





- Move the lever to the T side to return.

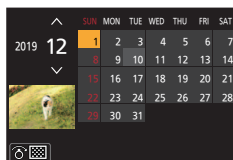

Multi Playback



Calendar Playback

- It is possible to switch the playback screen by touching the following icons.
 - : 1-picture screen
 - : 12-picture screen
 - : 30-picture screen
 - : Calendar screen
- The screen can be switched gradually by dragging the screen up or down.
- Pictures displayed with [!] cannot be played back.

Deleting pictures

Deleted pictures cannot be recovered.

[Delete Single]

1 Press [Fn7] button to delete displayed picture

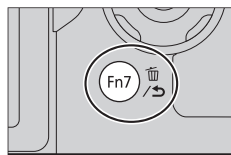

2 Use ▲ to select [Delete Single] and press [MENU/SET]

To delete multiple (up to 100*)/To delete all pictures

* A picture group is handled as 1 picture. (All the pictures in the selected picture group are deleted.)

1 Press [Fn7] button while viewing a picture

2 Use ▲▼ to select [Delete Multi]/[Delete All] and press [MENU/SET]

- You can select [Delete All Non-rating] in [Delete All] if there are pictures that have been set as [Rating].

(When [Delete Multi] is selected)

3 Use ▲▼◀▶ to select picture and press [MENU/SET]
(repeat)

 Picture selected

- To cancel → Press [MENU/SET] again.



4 Press [DISP.] button to execute

- May take time depending on number of pictures deleted.

Menu list

- You can display an explanation on the menu by pressing the [DISP.] button while you select a menu item or setting. (→30)

Menus to be displayed in each recording mode

[Intelligent Auto]

[Intelligent Auto Mode]

[iHandheld Night Shot]

[iHDR]

[Creative Video]

[Exposure Mode]

[High Speed Video]

[4K Live Cropping]

[Custom Mode]

You can select your preferred custom setting from [Set1], [Set2], and [Set3].

[Panorama Shot]

[Direction]

[Picture Size]

[Scene Guide]

[Scene Switch]

[Creative Control]

[Filter Effect]

[Simultaneous Record w/o Filter]

[Rec]

[Aspect Ratio]

[i.Resolution]*

[Burst Rate]

[Picture Size]

[Flash]

[4K PHOTO]

[Quality]

[Red-Eye Removal]

[Self Timer]

[AFS/AFF]*

[ISO Auto Upper Limit (Photo)]

[Time Lapse/Animation]

[AF Sensitivity(Photo)]

[Min. Shtr Speed]

[Silent Mode]

[Photo Style]*

[Long Shtr NR]

[Shutter Type]

[Filter Settings]*

[Diffraction Compensation]*

[Bracket]

[Color Space]

[Stabilizer]*

[HDR]

[Metering Mode]*

[i.Zoom]*

[Multi Exp.]

[Highlight Shadow]*

[Digital Zoom]*





[i.Dynamic]*

 [Motion Picture]

[Rec Format]	[Flkr Decrease]	[Sound Rec Level Limiter]
[Rec Quality]	[Level Shot]	[Wind Noise Canceller] / [Wind Cut]
[Snap Movie]	[Picture Mode in Rec.]	[Special Mic.]
[Continuous AF]	[Sound Rec Level Disp.]	[Zoom Mic]
[ISO Auto Upper Limit (Video)]	[Sound Rec Level Adj.]	

* The menu items are common for both [Rec] and [Motion Picture] menus. (Common menu items are indicated in the [Rec] menu list only) If a setting in one menu is changed, the setting with the same name in other menu will also be changed automatically.

 [Custom]

 [Exposure]	 [Operation]	[Highlight]
[ISO Increments]	[Fn Button Set]	[Zebra Pattern]
[Extended ISO]	[ISO Displayed Setting]	[Expo.Meter]
[Exposure Comp. Reset]	[Exposure Comp. Disp. Setting]	[MF Guide]
 [Focus / Release Shutter]	[Q.MENU]	[LVF/Monitor Disp. Set]
[AF/AE Lock]	[Dial Set.]	[Monitor Info. Disp.]
[AF/AE Lock Hold]	[Control Ring]	[Rec Area]
[Shutter AF]	[Operation Lock Setting]	[Remaining Disp.]
[Half Press Release]	[Video Button]	[Menu Guide]
[Quick AF]	[Video Rec. Button (Remote)]	 [Lens / Others]
[Eye Sensor AF]	[Touch Settings]	[Lens Position Resume]
[Pinpoint AF Setting]	[Zoom lever]	[Lens Retraction]
[AF Assist Lamp]	[Zoom Compose Assist]	[Face Recog.]
[Direct Focus Area]		[Profile Setup]
[Focus/Release Priority]	 [Monitor / Display]	
[Focus Switching for Vert / Hor]	[Auto Review]	
[Loop Movement Focus Frame]	[Monochrome Live View]	
[AF Area Display]	[Constant Preview]	
[AF+MF]	[Peaking]	
[MF Assist]	[Histogram]	
[MF Assist Display]	[Guide Line]	
	[Center Marker]	

 [Setup]

[Online Manual]	[Monitor Display Speed]	[Version Disp.]
[Cust.Set Mem.]	[LVF Display Speed]	[Folder / File Settings]
[Clock Set]	[Monitor Display]/ [Viewfinder]	[No.Reset]
[World Time]	[Monitor Luminance]	[Reset]
[Travel Date]	[m/ft]	[Reset Network Settings]
[Wi-Fi]	[Eye Sensor]	[Level Gauge Adjust.]
[Bluetooth]	[USB Mode]	[Demo Mode]
[Wireless Connection Lamp]	[TV Connection]	[Approved Regulations]
[Beep]	[Language]	[Format]
[Economy]		

 [My Menu]

[My Menu Setting]

 [Playback]

[Slide Show]	[4K PHOTO Bulk Saving]	[Rotate]
[Playback Mode]	[Light Composition]	[Video Divide]
[Protect]	[Sequence Composition]	[Time Lapse Video]
[Rating]	[Clear Retouch]	[Stop Motion Video]
[Title Edit]	[Text Stamp]	[Rotate Disp.]
[Face Rec Edit]	[Resize]	[Picture Sort]
[RAW Processing]	[Cropping]	[Delete Confirmation]

[Aspect Ratio]

Recording mode:   **P** **A** **S** **M**   

This allows you to select the aspect ratio of the pictures to suit printing or the playback method.

MENU →  [Rec] → [Aspect Ratio]
--

[4:3]	Aspect ratio of a 4:3 TV
[3:2]	Aspect ratio of standard film cameras
[16:9]	Aspect ratio of high-definition TV, etc.
[1:1]	Aspect ratio of a square image

[Picture Size]

Recording mode: **PAS** **M**

The higher the numbers of pixels, the finer the detail of the pictures will appear even when they are printed onto large sheets.

MENU → **[Rec]** → **[Picture Size]**

When [4:3] is selected

Settings	[Picture Size]
[L] (17.5M)	4864×3648
[EX M] (9M)	3456×2592
[EX S] (4.5M)	2432×1824

When [3:2] is selected

Settings	[Picture Size]
[L] (20M)	5472×3648
[EX M] (10M)	3888×2592
[EX S] (5M)	2736×1824

When [16:9] is selected

Settings	[Picture Size]
[L] (17M)	5472×3080
[EX M] (8M)	3840×2160
[EX S] (2M)	1920×1080

When [1:1] is selected

Settings	[Picture Size]
[L] (13.5M)	3648×3648
[EX M] (6.5M)	2592×2592
[EX S] (3.5M)	1824×1824

[Quality]

Recording mode: **PAS** **M**

Set the compression rate used for storing pictures.

MENU → **[Rec]** → **[Quality]**

	JPEG	Gives priority to picture quality and saves pictures in JPEG file format.
		Saves pictures in JPEG file format using standard picture quality.
[RAW]	RAW + JPEG	Saves pictures in both RAW and JPEG file format (or) simultaneously.
[RAW]		
[RAW]	RAW	Saves pictures in RAW file format.











- A RAW still picture is always recorded at [3:2] (5472×3648).
- If you delete a picture recorded in **[RAW]** or **[RAW]** from the camera, the corresponding RAW and JPEG pictures are also deleted.
- You can develop the RAW file pictures using [RAW Processing] in the [Playback] menu. (→67)
- To develop and edit RAW file pictures on a PC, use the software (Ichikawa Soft Laboratory's "SILKYPIX Developer Studio"). To get this software, download it from the supplier's website and install it on your PC. (→78)

[Photo Style]

Recording mode:   **P** **A** **S** **M**   

You can adjust the colors and picture quality according to the concept of the picture that you want to create.







MENU →  **[Rec]** /  **[Motion Picture]** → **[Photo Style]**

 STD. [Standard]	Standard setting.
 VIVID [Vivid]*	Setting with slightly high contrast and saturation.
 NAT [Natural]*	Setting with slightly low contrast.
 MONO [Monochrome]	Setting that creates a picture using monochrome shades of gray only, such as black and white.
 L.MONO [L.Monochrome]*	Setting that creates a monochrome picture using rich shades of gray with deep solid black tones.
 L.MONO D [L.Monochrome D]*	Setting that creates a dynamic monochrome picture with emphasized highlights and shadows.
 SCNY [Scenery]*	Setting that creates a picture using vivid colors for the blue sky and green.
 PORT [Portrait]*	Setting that produces the look of a healthy complexion.
 CUST [Custom]*	Setting for using colors and picture quality that were registered in advance.
 CNED [Cineline D]*	Gives priority to the dynamic range by using a gamma curve designed to create film-like images. Suited for editing.
 CNEV [Cineline V]*	Gives priority to the contrast by using a gamma curve designed to create film-like images.

* This setting is not available in Intelligent Auto Plus Mode.

■ Adjusting the picture quality

- ① Press ◀▶ to select the type of Photo Style
- ② Press ▲▼ to select an item and press ◀▶ to adjust

 [Contrast]	[+] / [-]
 [Sharpness]	[+] / [-]
 [Noise Reduction]	[+] / [-]
 [Saturation]*1	[+] / [-]
 [Color Tone]*1	[+] / [-]
 [Filter Effect]*2	[Yellow] / [Orange] / [Red] / [Green] / [Off]
 [Grain Effect]*2	[Low] / [Standard] / [High] / [Off] Sets the graininess in a picture.

*1 [Color Tone] is displayed only when [Monochrome], [L.Monochrome] or [L.Monochrome D] is selected. Otherwise, [Saturation] is displayed.



*2 Displayed only when [Monochrome], [L.Monochrome] or [L.Monochrome D] is selected.



- ③ Press [MENU/SET]

[Metering Mode]

Recording mode:        

You can change the metering method used for measuring brightness.

[MENU] →  [Rec] /  [Motion Picture] → [Metering Mode]

[Metering Mode]	Brightness measurement position	Conditions
 (Multiple)	Whole screen	Normal usage (produces balanced pictures)
 (Center weighted)	Center and surrounding area	Subject in center
 (Spot)	Center of [+] (spot metering target)	Great difference between brightness of subject and background (e.g. person in spotlight on stage, backlighting)

[Stabilizer]

Recording mode: **P** **A** **S** **M**

Automatically detects and prevents jitter. For motion picture recording, the 5-Axis Hybrid Image Stabilizer function is available. It uses both the optical stabilizer of the lens and the electronic stabilizer of the camera's sensor.

MENU → **[Rec]** / **[Motion Picture]** → **[Stabilizer]**

[Operation Mode]	(Normal)	Corrects vertical and horizontal jitter.
	(Panning)	Corrects vertical jitter. This setting is ideal for panning. We recommend using the Viewfinder.
	[OFF]	[Stabilizer] does not work.
[E-Stabilization (Video)]	Corrects jitters that occur in 5 directions during motion picture recording, namely the vertical direction, horizontal direction, rotation axis, vertical rotation, and horizontal rotation (5-axis Hybrid Image Stabilizer function). [ON] / [OFF]	

[Silent Mode]

Recording mode: **P** **A** **S** **M**

Disabling the beeps and flash at the same time.

MENU → **[Rec]** → **[Silent Mode]**

Settings: **[ON] / [OFF]**

- This mode will mute sounds from the speaker and disable the flash and AF Assist Lamp.
The settings for the following functions are fixed:
 - [Flash Mode]: (Forced Flash Off)
 - [Shutter Type]: [ESHTR]
 - [AF Assist Lamp]: [OFF]
 - [Beep Volume]: (Off)
 - [Shutter Vol.]: (Off)
- Even when this mode is set to [ON], the following lamps/indicators will light or flash.
 - Self-timer indicator
 - WIRELESS connection lamp
- The operation sounds of this camera such as the lens aperture sound are not muted.
- **Be sure to pay special attention to the privacy, the likeness rights, etc. of the subject when you use this function. Use at your own risk.**

[Shutter Type]

Recording mode: **P** **A** **S** **M**

You can take pictures using two types of shutter modes: the mechanical shutter and electronic shutter.

MENU → **[Rec]** → **[Shutter Type]**

[AUTO]	The shutter mode automatically switches based on the recording conditions and shutter speed.
[MSHTR]	Uses only the mechanical shutter mode to take a picture. Shutter Speed (seconds): B (Bulb)*1, 60 - 1/4000
[ESHTR]*2	Uses only the electronic shutter mode to take a picture. Shutter Speed (seconds): 1 - 1/16000

*1 This setting is available only in Manual Exposure Mode.

*2 The flash is fixed to the (Forced Flash Off) setting.

[Monitor Display Speed] / [LVF Display Speed]

Sets the display speed of the monitor or viewfinder.

MENU → **[Setup]** → **[Monitor Display Speed] / [LVF Display Speed]**

[ECO 30fps]	Minimizes power consumption and the operating time is extended.
[60fps]	You can display a moving subject in fluid motion. This setting is ideal for recording fast-moving subjects.

- When [Monitor Display Speed] or [LVF Display Speed] (or both) is set to [ECO 30fps], Digital Zoom is not available.
- The [Monitor Display Speed]/[LVF Display Speed] setting does not affect the recorded picture.

[My Menu]

You can register frequently used menus and display them on [My Menu]. Up to 23 menus can be registered.

MENU → **[My Menu]** → **[My Menu Setting]**



[Add]	Select and register a menu to be displayed on [My Menu].
[Sorting]	Change the order of the menus to be displayed on [My Menu]. Select the menu whose order you want to change and set the new location.
[Delete]	Delete a registered menu from the [My Menu] display. [Delete Item]: Select and delete a menu from the displayed menus. [Delete All]: Delete all displayed menus.
[Display from My Menu]	Set a screen to be displayed when the menu screen is displayed. [ON]: Displays [My Menu] [OFF]: Displays the last menu used

[RAW Processing]

You can use the camera to develop still pictures that were recorded in RAW format. The created still pictures are saved in JPEG format.

MENU →  **[Playback]** → **[RAW Processing]**

1 Press   to select RAW file and press **[MENU/SET]**

2 Press   to select the item and then press **[MENU/SET]** to set

- The following items can be set. The settings used during recording are applied at the time of setting.

[White Balance]	[Highlight]
[Brightness correction]	[Shadow]
[Photo Style]	[Saturation] / [Color Tone]
[i.Dynamic]	[Filter Effect]
[Contrast]	[Grain Effect]

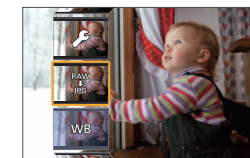

[Noise Reduction]
[i.Resolution]
[Sharpness]
[More Settings]





3 Press **[MENU/SET]** to finalize the setting

- The screen in step 2 reappears. To set another item, repeat steps 2 to 3.

4 Press   to select **[Begin Processing]** and press **[MENU/SET]**

■ Setting each item

When you select an item, the setting screen appears.

Operation	Touch operation	Description
	Drag	Used to make adjustments
	[WB K Set]	Used to display the color temperature setting screen (Only when [White Balance] is set to )
	[Adjust.]	Used to display the White Balance fine adjustment screen (Only when [White Balance] is set)
[DISP.]	[DISP.]	Used to display the comparison screen
[MENU/SET]	[Set]	Used to finalize an adjustment you just made and to return to the item selection screen

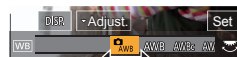
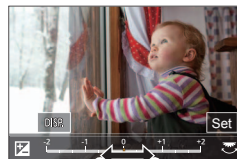

- If you have selected [Noise Reduction], [i.Resolution], or [Sharpness], the comparison screen is not displayed.
- You can also zoom in by quickly touching the display twice. (If the display was enlarged, it returns to the same magnification ratio.)

The following operating methods are available to make adjustments on the comparison screen.

Ⓐ Current setting

Operation	Touch operation	Description
	Drag	Used to make adjustments
[DISP.]	[DISP.]	Used to return to the setting screen
[MENU/SET]	[Set]	Used to finalize an adjustment you just made and to return to the item selection screen

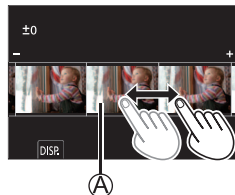

- If you touch the picture at the center, it will be enlarged. If you touch [↩], the picture will be reduced to the original size.

[Light Composition]

Select multiple frames from 4K burst files that you wish to combine. Parts of the image that are brighter than the preceding frame will be superimposed on the preceding frame to combine the frames into one picture.

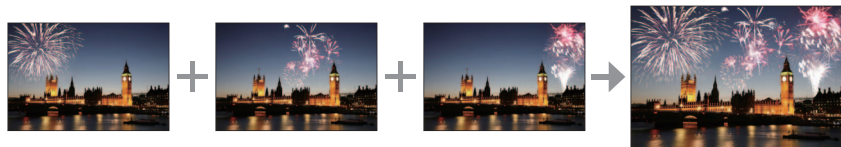

[MENU] → **[Playback]** → **[Light Composition]**

- 1 Use ◀▶ to select the 4K burst files and press **[MENU/SET]**
- 2 Choose the combining method and press **[MENU/SET]**

■ [Composite Merging]: Selecting frames to combine

① Drag the slide bar or use ▲ ▼ ◀ ▶ to select the frames to combine

② Press [MENU/SET]

- The selected frames are remembered, and the display goes to the preview screen.

- Use ▲ ▼ to select items and press [MENU/SET] to perform the following operations.

- [Next]: Lets you select more frames for combining.

- [Reselect]: Discards the frame selected immediately before and lets you select a different image.

③ Repeat steps ① - ② to select more frames to combine (up to 40 frames)

④ Press ▼ to select [Save] and press [MENU/SET]

■ [Range Merging]: Selecting a range to combine

① Select the frame of the first picture and then press [MENU/SET]

- The selection method is the same as in step ① of [Composite Merging] setting.

② Select the frame of the last picture and then press [MENU/SET]



● The picture will be saved in JPEG format.

[Sequence Composition]

Select multiple frames from a 4K burst file to create a sequence composition of a moving subject into one picture.



[MENU] → [▶] [Playback] → [Sequence Composition]

1 Use ◀▶ to select the 4K burst files and press [MENU/SET]**2 Select frames to combine**

Select the frames so that the moving subject will not overlap on the preceding or subsequent frames. (The sequence composition may not be created properly if the subject overlaps.)

① Drag the slide bar or use ▲▼◀▶ to select the frames to combine

② Press [MENU/SET]

- The selected frames are remembered, and the display goes to the preview screen.

- Use ▲▼ to select items and press [MENU/SET] to perform the following operations.

- [Next]: Lets you select more frames for combining.

- [Reselect]: Discards the frame selected immediately before and lets you select a different image.

③ Repeat steps ① - ② to select more frames to combine (from 3 to 40 frames)

④ Press ▼ to select [Save] and press [MENU/SET]

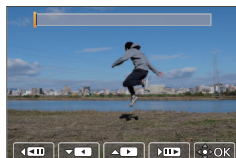

- We recommend using a tripod to take pictures for Sequence Composition.

- The picture will be saved in JPEG format.

[Video Divide]

A single motion picture can be split into 2 parts. This is convenient when you want to keep just the necessary scenes, or if you wish to delete unnecessary scenes to increase free space on your card, such as when traveling.

[MENU] → **[▶]** **[Playback]** → **[Video Divide]**

1 Use ◀▶ to select a motion picture to split and press [MENU/SET]

2 Press ▲ at where you want to split a motion picture to pause it

- If you press ◀▶ while paused, you can make finer adjustments to the splitting positions in a motion picture.

3 Press ▼

- The original motion picture that was split does not remain.



- Motion pictures cannot be divided at a location close to the start or end of the motion picture.

What you can do with the Wi-Fi®/Bluetooth® function

Operating the camera by connecting it to a smartphone

- Operating the shutter button of the camera using a smartphone (remote recording) (→76)
- Playing back or saving images stored on the camera, or uploading them on social media sites (→77)
- Combining motion pictures recorded with Snap Movie according to your preference on a smartphone

Expanding the scope of applications by connecting the camera to a smartphone compatible with Bluetooth Low Energy

- Pairing (connection setup) (→72)
 - Turning on/off the camera with a smartphone (→75)
 - [B] (Bulb) recording
 - Transferring recorded images to a smartphone automatically
 - Writing location information of a smartphone on a recorded image (→77)
 - Synchronizing the camera's clock with a smartphone
- This manual uses the term "smartphone" for both smartphones and tablets unless it is necessary to distinguish between them.
 - For details, refer to "Owner's Manual for advanced features (PDF format)".

■ Lighting of the WIRELESS connection lamp (Blue)

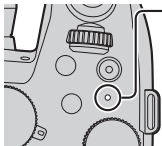

Lit: When the Wi-Fi/Bluetooth function is ON or connected
 Blinking: When sending picture data by operating the camera

- In [Wireless Connection Lamp] in the [Setup] menu, you can set the lamp so that it will not light/flash.

■ [Wi-Fi] button

In this owner's manual, a function button to which [Wi-Fi] is assigned is referred to as the [Wi-Fi] button. (At the time of purchase, [Wi-Fi] is assigned to [Fn9] in recording mode, and [Fn5] in playback mode.)

- For details on the function button, refer to (→31)

To start up the Wi-Fi function (When in recording mode):

- ① Touch [Fn]
- ② Touch [Wi-Fi]



- The camera cannot be used to connect to a public wireless LAN connection.

Operating the camera by connecting it to a smartphone

Installing the smartphone app “Panasonic Image App”

Supported OS	Android™: Android 4.4 or later (Android 5.0 or higher is required to use the Bluetooth function) iOS: iOS 9.3 or later (The Bluetooth function cannot be used with the iPad 2)
---------------------	---

- ① Connect your device to a network
- ② (Android) Select “Google Play™ Store”
(iOS) Select “App Store”
- ③ Enter “Panasonic Image App” or “LUMIX” into the search box
- ④ Select “Panasonic Image App” and install it



- Use the latest version.
- Supported OS versions as of February 2019. Supported OS versions may be changed without prior notice.
- The service may not be able to be used properly depending on the type of smartphone being used.

For the latest information on the “Image App”, refer to the support site below.

<https://panasonic.jp/support/global/cs/dsc/>

(This site is available in English only.)

- When downloading the app on a mobile phone network, high packet communication fees may be incurred depending on the details of your contract.
- For details about the operating procedure, etc., refer to [Help] in the “Image App” menu.
- When you operate the “Image App” on the smartphone that is connected to the camera via Wi-Fi, [Help] in the “Image App” may not be displayed depending on the smartphone. In this case, after terminating the connection to the camera, reconnect the smartphone to a mobile phone network or to a Wi-Fi router, and then display [Help] in the “Image App”.
- Some of the screens and information provided in this document may be different depending on the supported operating system and “Image App” version.

Connecting the camera to a smartphone compatible with Bluetooth Low Energy

You can connect the camera to a smartphone via a Bluetooth connection.

Supported smartphones	Android: Android 5.0 or higher equipped with Bluetooth 4.0 or higher (excluding those that do not support Bluetooth low energy) iOS: iOS 9.3 or higher (excluding the iPad 2)
------------------------------	---

■ First-time connection

You need to set up pairing (connection) for the first time only. When pairing is set up, a Wi-Fi connection is made automatically.

(On the camera)

MENU → **[Setup]** → **[Bluetooth]** → **[Bluetooth]**
→ **[SET]** → **[Pairing]**

- The camera enters pairing standby mode and displays its device name.

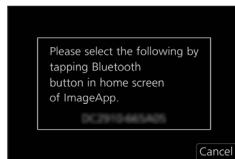

(On your smartphone)

- ① Start "Image App"
 - If a message is displayed indicating that the smartphone is searching for cameras, close the message.
- ② Select [Bluetooth]
- ③ Turn on the Bluetooth
- ④ Select the device name displayed on the camera's screen from the [Camera enable to be registered] list
 - Bluetooth connection between the camera and the smartphone will be made.
 - (For Android devices) A Wi-Fi connection will be made by selecting [Connection].

If you are using an Android device, follow the steps up to here to complete the setup.

Proceed to the steps below only if you are using an iOS device.

- If [Wi-Fi Password] (→74) is set to [OFF] on the camera, select [Wi-Fi Setup]. (At the time of purchase, [Wi-Fi Password] is set to [OFF])
 - If [Wi-Fi Password] is set to [ON] on the camera, you need to install the profile.
 - ① Install the profile
 - If the smartphone is locked with a passcode, enter the passcode to unlock the smartphone.
 - ② Exit the browser
 - ⑤ Turn on the Wi-Fi function in the setting menu
 - ⑥ On the Wi-Fi setting screen, select the SSID displayed on the camera (The device name selected in step ④)
 - If the SSID is not displayed, it may be displayed after the Wi-Fi function is turned off and on.
 - When you need to change the connected device, follow the on-screen message to change the setting.
 - ⑦ Start "Image App"
 - The paired smartphone will be registered as a paired device after connected via Wi-Fi.
- To make a connection with the paired smartphone for the second and subsequent times, enable the Bluetooth function of the camera and set the Bluetooth for "Image App" on your smartphone to ON. Then, select a camera (device name) to be connected from the [Camera registered] list.
- is displayed on the recording screen when a Bluetooth device is connected. If the Bluetooth function is enabled, but the smartphone is not connected, the displayed is semi-transparent.

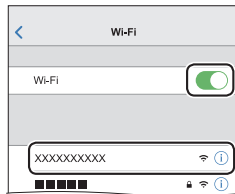

Connecting the camera to a smartphone that does not support Bluetooth Low Energy

You can easily establish a Wi-Fi connection on this unit without entering a password on your smartphone.

(On the camera)

MENU →  **[Setup]** → **[Wi-Fi]** → **[Wi-Fi Function]** → **[New Connection]**
→ **[Remote Shooting & View]**

- The information required for directly connecting your smartphone to this unit (SSID (A)) is displayed.
- You can also display the information by pressing the function button that [Wi-Fi] function is assigned.



(On your smartphone)

- 1 Turn on the Wi-Fi function in the setting menu
- 2 Select the SSID displayed on the screen of the camera
- 3 Start "Image App"

- When the connection confirmation screen appears on the camera, select [Yes] and press [MENU/SET]. (Only when making a connection for the first time.)

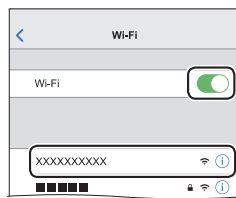

[Wi-Fi Password] is set to [OFF] at the time of purchase. When you start a Wi-Fi connection, be sure to verify that the device displayed on the camera's connection confirmation screen is really the device you want to connect to. Even if the wrong device is displayed, you will still be connected to it if you select "Yes". If there seem to be other Wi-Fi enabled devices in the vicinity, we recommend that you set [Wi-Fi Password] to [ON]. For details, refer to "Owner's Manual for advanced features (PDF format)".

Closing the Wi-Fi connection

1 Set the camera to Recording Mode

- Press the shutter button halfway to return to recording mode.

2 Select the camera's menu items to terminate the Wi-Fi connection

MENU →  [Setup] → [Wi-Fi] → [Wi-Fi Function] → [Yes]

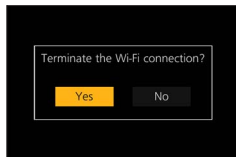

3 On the smartphone, close "Image App"

Turning on/off the camera with a smartphone

Wireless connectivity required: **Bluetooth** **Wi-Fi**

This function allows you to turn on the camera from a distant location and take pictures or view images on the camera even when it is in your bag.

1 Make a Bluetooth connection to the smartphone (→72)

2 Select the camera's menu

MENU →  [Setup] → [Bluetooth] → [Remote Wakeup] → [ON]

3 Set the Camera [ON/OFF] switch to [OFF]

4 On the smartphone, start up the "Image App", and set the Bluetooth function to a state in which a connection can be made (standby state)

5 Operate the smartphone

① Select []

② Select [Remote operation]

- The camera automatically turns on, allowing it to make a Wi-Fi connection automatically. (iOS devices) Depending on the connection status of the smartphone, you may need to change the connected device on the Wi-Fi setup screen. Follow the on-screen message on the smartphone to change the setting.



■ Turning off the camera with the smartphone

① Select []

② Select [ OFF]

- When [Remote Wakeup] is set to [ON], the Bluetooth function continues to operate even after the camera is turned off, thus causing the battery to drain.

Operating the shutter button of the camera using a smartphone (remote recording)

Wireless connectivity required: **Wi-Fi**

1 Connect to a smartphone (→74)

2 Operate the smartphone

If the camera is already connected to the smartphone via Bluetooth, select [] → [Remote operation].

(iOS devices) When you need to change the connected device on the Wi-Fi setup screen, follow the on-screen message to change the setting.

① Select []

② Take pictures

- The recorded images are saved in the camera.
- Some settings are not available.



Using the smartphone to operate the shutter button via a Bluetooth connection only

Wireless connectivity required: **Bluetooth**

1 Make a Bluetooth connection to the smartphone (→72)

2 Operate the smartphone

① Select []

② Select [Shutter Remote Control]

③ Take pictures



- [Shutter Remote Control] is available only when the Camera [ON/OFF] switch is set to [ON].
- Read the [Help] in the "Image App" menu for further details on how to operate [Shutter Remote Control] of "Image App".

Playing back or saving images stored on the camera, or uploading them on social media sites

Wireless connectivity required: **Wi-Fi**

1 Connect to a smartphone (→74)

2 Operate the smartphone

If the camera is already connected to the smartphone via Bluetooth, select [] → [Remote operation].

(iOS devices) When you need to change the connected device on the Wi-Fi setup screen, follow the on-screen message to change the setting.

① Select []

- You can switch a device of pictures to be displayed using the icon at the top left on the screen. Select [LUMIX] to display a picture saved in the camera.

(Playing back a picture)

- ② When the picture is touched, it is played back at a larger size

(Saving and sending pictures to web services such as SNS)

- ③ Press and hold the picture and drag it

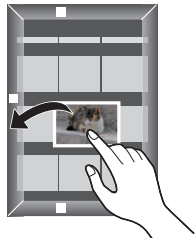

Writing location information of a smartphone on a recorded image

Wireless connectivity required: **Bluetooth**

The smartphone sends its location information to the camera via Bluetooth, and the camera performs recording while writing the acquired location information.

Preparation

Enable the GPS function on the smartphone.

1 Make a Bluetooth connection to the smartphone (→72)

2 Select the camera's menu

MENU → [Setup] → [Bluetooth] → [Location Logging] → [ON]

- The camera will enter a mode where location information can be recorded and [GPS] will be displayed on the recording screen.

3 Take pictures on the camera

- Location information will be written to the recorded pictures.
- When the displayed [GPS] is semi-transparent, location information is not acquired, so data cannot be written.

Downloading software

Download and install software to edit and play back images with a PC.

- To download the software, your PC must be connected to the Internet.
- It may take time to download the software in some communication environments.

PHOTOfunSTUDIO 10.0 AE (Windows® 10 / 8.1 / 7)

You can capture still pictures or motion pictures to your PC, or organize captured pictures by categorizing by recording date, model name of the digital camera used to record, etc.

You can also correct still pictures, edit motion pictures, or write to DVD.

The software is available for download until the end of March 2024.

https://panasonic.jp/support/global/cs/soft/download/d_pfs10ae.html

- For details about information such as the operating environment or operating method, refer to the “Owner’s Manual for advanced features (PDF format)” or the operating instructions of “PHOTOfunSTUDIO” (PDF format).

SILKYPIX Developer Studio SE (Windows® 10 / 8.1 / 7, Mac OS X v10.10, v10.11, macOS 10.12 - 10.14)

This software develops and edits RAW file pictures. Edited pictures can be saved in a file format such as JPEG or TIFF that can be displayed on a PC, etc.

<http://www.isl.co.jp/SILKYPIX/english/p/>

- For details on the operating environment and how to use the SILKYPIX Developer Studio, refer to the “Help” or the Ichikawa Soft Laboratory’s support website.

LoiLoScope 30 day full trial version (Windows® 10 / 8.1 / 8 / 7)

Motion pictures can be edited easily.

<http://loilo.tv/product/20>









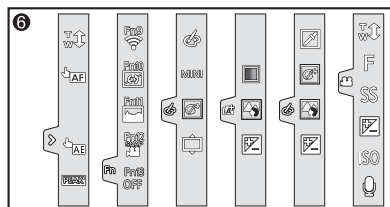
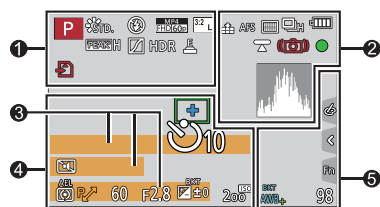



- For more information on how to use LoiLoScope and its operating environment, read the LoiLoScope manual available for download at the website.

















List of monitor/viewfinder displays







- The following images are examples of when the display screen is set to  (monitor style) in the monitor.

In recording



1	 P	Recording mode (→25)
	C 1	Custom Set
	 STD.	[Photo Style] (→63)
	 Flash	Flash setting (→51)
	 MP4 FHD 60p	[Rec Format]/ [Rec Quality] (→53)
	 SNAP 4SEC	[Snap Movie]
	 3:2 L	[Aspect Ratio] (→61)/ [Picture Size] (→62)
	 STD.	Image size (Panorama Shot Mode)
	 EXPS	Picture effect (Filter) adjustment display Types of picture effects (Filter)
	 Card	Card (displayed only during recording)
	XXhXXmXXs	Elapsed recording time*1
	 Camera	Simultaneous recording indicator (When taking still pictures while recording a motion picture)
	LVF/MON AUTO	Automatic switching between viewfinder and monitor (→22)
	 PEAK H	[Peaking]
	 HDR	[Highlight Shadow] [HDR]/[iHDR]
	 E	[Multi Exp.] Electronic shutter

2	 Photo Priority	Picture-taking during motion picture recording (Photo Priority)
	 Overheat	Overheat indicator (→43, 45, 52)
	 120fps	[Quality] (→62) [High Speed Video]
	AFS	Focus Mode (→34, 36)
	BKT AFS	Focus Bracket (→50)
	 AF Mode	[AF Mode] (→35)
	 Pull Focus	[Pull Focus] ([Snap Movie])
	 Face Recog.	[Face Recog.]
	AFL	AF Lock (→37)
	 Burst	Burst (→41)
	 4K PHOTO	[4K PHOTO] (→42)
	 Post Focus	[Post Focus] (→45)
	 Time Lapse Shot	[Time Lapse Shot] (→47)
	 Stop Motion Animation	[Stop Motion Animation] (→48)
	 Self Timer	[Self Timer] (→41)
	 Battery	Battery indicator
	AF Macro	Macro recording (→35)
	 Level Shot	[Level Shot]
	 Stabilizer	[Stabilizer] (→65)
	 Jitter alert	[Jitter alert]

	Focus (Lights green.) (→23)/ Recording state (Lights up in red.) (→52)
	Focus (Under low illumination)
	Focus (Starlight AF)
	Wi-Fi connection status
	Bluetooth connection status (→73)
	Location Logging (→77)
	Histogram

③

Name*2

Travel elapsed days*3

Age in years/months*2

Location*3





















Current date/time*3

Travel destination setting*3: 







Exposure meter

Zoom (→24)

④



















	AF area
	Spot metering target (→64)
	[Center Marker]
	[Self Timer] (→41)
	[Zoom Mic]
	[Sound Rec Level Disp.]
	External Microphone
	[Silent Mode] (→65)
	[Sound Rec Level Limiter] ([OFF])
	AE Lock (→37)
	[Metering Mode] (→64)
	Program Shift
	Shutter speed
	Aperture value
	Aperture Bracket (→50)
	Exposure Compensation (→37)
	Exposure Bracket (→50)
	Brightness (exposure) (→33)
	Manual Exposure Assist
	ISO sensitivity (→38)

⑤

	White Balance (→39)
	White Balance Bracket (→40)
	White Balance Fine Adjustment (→40)
	Coloring
	Number of recordable pictures
	Maximum number of pictures that can be taken continuously
	Available recording time*1

⑥

Touch tab

	Touch zoom
	Touch Shutter (→29)
	Touch AF (→29)
	[Touch AE] (→29)
	[Peaking]
	Function buttons (→31)
	Coloring (→33)
	Defocus control function (→33)
	Brightness (exposure) (→33)
	Type of defocus ([Miniature Effect])
	[One Point Color]
	[Sunshine]
	Picture effect (Filter) adjustment display
	Picture effects ON or OFF
	Picture effects (Filter)
	Aperture value (→54)
	Shutter speed (→54)
	ISO sensitivity (→54)
	[Sound Rec Level Adj.] (→54)

■ On-monitor recording information

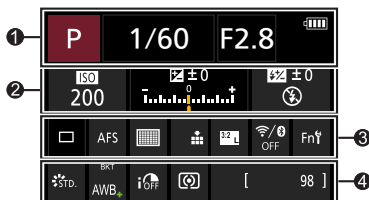

1		Recording mode (→25)
	1/60	Shutter speed
	F2.8	Aperture value
		Battery indicator

2		ISO sensitivity (→38)
		Exposure Compensation (→37)
		Exposure Bracket (→50)
		Brightness (exposure) (→33)
		Manual Exposure Assist
		Flash setting (→51)

3		[Single] (→41)
		[Burst] (→41)
		[4K PHOTO] (→42)
		[Post Focus] (→45)
		[Time Lapse Shot] (→47)

	[Stop Motion Animation] (→48)
	[Self Timer] (→41)
AFS	Focus Mode (→34, 36)
	[AF Mode] (→34)
	[Quality] (→62)
	[Aspect Ratio] (→61)/ [Picture Size] (→62)
	Wi-Fi/Bluetooth (→71)
Fn	Function button setting (→31)

4		[Photo Style] (→63)
	AWB	White Balance (→39)
		White Balance Bracket (→40)
		White Balance Fine Adjustment (→40)
		[i.Dynamic]
		[Metering Mode] (→64)
	98	Number of recordable pictures
	r20	Maximum number of pictures that can be taken continuously
	RXXmXXs	Available recording time *1

*1 [h], [m] and [s] indicate "hour", "minute" and "second".

*2 This is displayed for about 5 seconds when the camera is turned on if the [Profile Setup] setting is set.

*3 This is displayed for about 5 seconds when the camera is turned on, after setting the clock and after switching from Playback Mode to Recording mode.

- The information displayed, such as histograms, magnifications, and numeric values, are only for the purpose of reference.

Q&A Troubleshooting

- Performing [Reset] in the [Setup] menu may resolve the issue.
- Further information is provided in the “Owner’s Manual for advanced features (PDF format)”. Check it together with the information in this section.

The charging lamp blinks.

- Charging is being performed in a place with extremely high or low temperature.
→ **Reconnect the USB connection cable (supplied) and retry charging in a place where ambient temperature is 10 °C to 30 °C (50 °F to 86 °F) (temperature conditions also apply to the battery itself).**
- Charging is not possible if the power supply capacity of the computer is low.

Camera does not work even if the camera is turned on. Camera switches off as soon as the camera is turned on.

- Battery needs recharging.
→ Charge the battery. (→19)

The battery runs down quickly.

- When [Pre-Burst] ([4K Pre-Burst]) has been selected, the battery drains faster. Select [4K Pre-Burst] only when recording.

Multiple pictures are taken when I press the shutter button just once.

Check the following settings. If any of them apply, multiple pictures will be taken.

- Drive Mode is set to other than [Single]. (→41)
→ Set Drive Mode to [Single].
- Bracket recording is set. (→49)
→ If any of the [BKT] icons (ex. [BKT ±0], [BKT 2.8], [BKT AFS], [BKT AWB], etc.) is displayed on the screen, bracket recording is set. Under [Bracket] in the [Rec] menu, set [Bracket Type] to [OFF].

Focus not aligned correctly.

- Subject outside of focus range.
- [Focus/Release Priority] is set to [RELEASE]. (→60)
- [Shutter AF] is set to [OFF]. (→60)
- AF Lock is set inappropriately. (→37)
- If there are fingerprints or dirt on the lens, the focus may be set to the lens and not the subject.

Recorded pictures are blurred. The stabilizer function ineffective.

- Shutter speed is slower in dark locations and the stabilizer function is less effective.
→ Use a tripod and the self-timer (→41) when using a slower shutter speed.

Striping or flicker may appear under lighting such as fluorescent lighting and LED lighting fixture.

- This is a characteristic of MOS sensors which serve as the camera’s pickup sensors. This is not a malfunction.
- If you are taking still pictures using the electronic shutter, the striping may be reduced by setting a slower shutter speed.
- When noticeable flicker or striping is seen under lighting such as a fluorescent or LED lighting fixture in the motion picture recording mode, you can reduce the flicker or striping by setting up [Flkr Decrease] (→60) and fixing the shutter speed. You can set the shutter speed manually in the Creative Video Mode. (→25)

Subject appears skewed in pictures.

- If you take a picture of a moving subject in the electronic shutter mode, motion picture recording mode, or 4K photo recording mode, the subject in the picture may be skewed in some cases. This is characteristic of MOS sensors which serve as the camera's pickup sensors. This is not a malfunction.

Brightness or coloring of recorded picture different from real life.

- When recording under fluorescent or LED lighting fixture etc., increasing the shutter speed may introduce slight changes to brightness and color. These are a result of the characteristics of the light source and do not indicate a malfunction.
- When recording subjects in extremely bright locations or recording under fluorescent lighting, LED lighting fixture, mercury lamp, sodium lighting etc., the colors and screen brightness may change or horizontal striping may appear on the screen.

4K photo recording stops before finishing.

- When the ambient temperature is high or recording of the 4K Photo function is performed continuously, the camera may display [] and stop the recording. Wait until the camera cools down.

Cannot record motion pictures.

- When a large capacity card is used, you may not be able to take a picture for a while after you turn on the camera.



Motion picture recording stops midway.

- When the ambient temperature is high or motion picture is recorded continuously, the camera may display [] and stop the recording. Wait until the camera cools down.
- The speed class of a required card varies depending on [Rec Format] and [Rec Quality] of a motion picture. Be sure to use a card of the recommended speed class (→15).

Sometimes focus adjustment with Auto Focus mode is difficult while recording 4K motion pictures.

- This may occur when taking a picture by reducing the Auto Focus speed in order to adjust the focus at high precision. This is not a malfunction.

No flash emitted.

- The flash becomes unavailable in the following cases.
 - The flash is closed. (→51)
 - Flash set to [] (Forced Flash Off).
- The flash is fixed to [] (Forced Flash Off) in the following cases:
 - During motion picture recording
 - When recording 4K photos
 - When recording using [Post Focus]
 - When using the electronic shutter
 - When [HDR] is set to [ON]
 - When [Silent Mode] is set to [ON]
 - When a picture effect in [Filter Effect] of [Filter Settings] is set
- Set [Shutter Type] to [AUTO] or [MSHTR]. (→59)
- Set [Silent Mode] to [OFF]. (→59)

The monitor/viewfinder is turned off although the camera is turned on.

- If no operations are performed during the set time period [Auto LVF/Monitor Off] (→22) is activated, and the monitor/viewfinder turns off.
- When a hand or an object is close to the eye sensor, the monitor display mode could be switched to viewfinder display mode. (→22)

Cannot view pictures. There are no recorded pictures.

- A card is not inserted in the camera.
- Has the file name of the picture been changed on a computer? If so, it cannot be played back on the camera.
→ It is recommended to use the "PHOTOfunSTUDIO" software (→78) to write pictures from PC to card.
- Set [Playback Mode] to [Normal Play]. (→61)

A Wi-Fi connection cannot be established. Radio waves get disconnected. Wireless access point is not displayed.

General tips for using a Wi-Fi connection

- Use within the communication range of the wireless LAN network.
- Is any device, such as a microwave oven, cordless phone, etc., that uses 2.4 GHz frequency operated nearby?
→ Radio waves may get interrupted when used simultaneously. Use them sufficiently away from the device.
- When the battery indicator is flashing red, the connection with other equipment may not start or the connection may be disrupted. (A message such as [Communication error] is displayed.)
- When this unit is placed on a metal table or shelf, the connection may not be established easily. Use the camera away from metal surfaces.

About a wireless access point

- Check if the wireless access point to connect is in operating state.
- Check the radio wave condition of the wireless access point.
→ Perform the connection closer to the wireless access point.
→ Move the location or change the angle of the wireless access point.
- It may not display even if the radio waves exist depending on the setting of the wireless access point.
→ Turn off the wireless access point and then turn it back on.
- Is the network SSID of the wireless access point set not to broadcast?
→ It may not be detected when it is set not to broadcast. Enter and set the network SSID. Alternatively, set the network SSID of the wireless access point to broadcast.

It takes time to transmit an image to the WEB service.**Transmission of the image fails midway. There is an image that could not be transmitted.**

- Is the size of the image too large?
→ Transmit after dividing the motion picture with [Video Divide].
→ Reduce the image size at [Size], and then send.
- It may take longer time to transmit when distance to the wireless access point is far.
→ Transmit closer to the wireless access point.
- File format of the picture that can be sent differs depending on the destination.

The lens makes a clicking noise.

- When the camera is turned on or off, the lens is moved, or an aperture operation is performed, such a noise may be heard. This is not a malfunction.
- When the brightness changes after a zooming operation or moving the camera, the lens may make a noise while adjusting the aperture. This is not a malfunction.

Zooming stops instantaneously.

- When using the Extended optical zoom, the zooming action will stop temporarily. This is not a malfunction.

Camera is hot.

- Camera may become a little warm during use, but this does not affect performance or quality.

Clock is incorrect.

- If you do not use the camera for a long time, the clock may be reset.
→ Reset the clock (→21).

Specifications

Digital Camera: Information for your safety

Power Source	DC 8.4 V (8.4 V ---)
Power Consumption	1.9 W (When recording with monitor) 2.9 W (When recording with viewfinder) 1.5 W (When playing back with monitor) 1.5 W (When playing back with viewfinder)
Camera effective pixels	20,100,000 pixels
Image sensor	1" MOS sensor, total pixel number 20,900,000 pixels Primary color filter
Lens	Optical 16x zoom f=9.1 mm to 146 mm (35 mm film camera equivalent: 25 mm to 400 mm) Max. Wide: F2.8 to F11 Max. Tele: F4.0 to F11
Image Stabilizer	Optical method
Focus range	AF: 30 cm (0.98 feet) (Max. Wide)/1 m (3.3 feet) (Max. Tele) to ∞ AF Macro/MF/Intelligent Auto/Motion picture: 3 cm (0.098 feet) (Max. Wide)/1 m (3.3 feet) (Max. Tele) to ∞
Shutter system	Electronic shutter + Mechanical shutter
Minimum Illumination	Approx. 9 lx (when i-Low light is used, the shutter speed is 1/30th of a second)
Shutter speed	Still picture: B (Bulb) (Max. approx. 120 seconds), 60 seconds to 1/4000th of a second (When the mechanical shutter is used), 1 second to 1/16000th of a second (When the electronic shutter is used) Motion picture: 1/25th of a second to 1/16000th of a second (When [FHD/24M/24p] is set in [AVCHD]), 1/2 second to 1/16000th of a second (When [Exposure Mode] is set to [M] in Creative Video Mode and [MF] is selected), 1/30th of a second to 1/16000th of a second (Other than the above)
Exposure (AE)	Program AE (P)/Aperture-priority AE (A)/ Shutter-priority AE (S)/Manual exposure (M) Exposure Compensation (1/3 EV steps, -5 EV to +5 EV)

Metering Mode	Multiple/Center weighted/Spot
Monitor	3.0" TFT LCD (3:2) (Approx. 1,240,000 dots) (field of view ratio about 100%) Touch screen
Viewfinder	0.39" OLED Live Viewfinder (4:3) (Approx. 2,360,000 dots) (field of view ratio about 100%) [Approx. 0.74x (35 mm film camera equivalent), with 50 mm lens at infinity; -1.0 m ⁻¹] (with diopter adjustment -4 to +4 diopter)
Flash	Built-in pop up flash AUTO, AUTO/Red-Eye Reduction, Forced ON, Forced ON/Red-Eye Reduction, Slow Sync., Slow Sync./Red-Eye Reduction, Forced OFF
Microphones	Stereo
Speaker	Monaural
Recording media	SD Memory Card/SDHC Memory Card*/SDXC Memory Card* * UHS-I UHS Speed Class 3
Recording file format	
Still picture	RAW/JPEG (based on Design rule for Camera File system, based on Exif 2.31 standard)
4K Photo	MP4
Motion picture	AVCHD Progressive/AVCHD/MP4
Audio compression format	AVCHD: Dolby Audio™ (2 ch) MP4: AAC (2 ch)
Interface	
[MIC]	Ø3.5 mm jack
[REMOTE]	Ø2.5 mm jack
[HDMI]	Micro HDMI Type D
[USB/CHARGE]	USB 2.0 (High Speed)/USB 2.0 Micro-B
Dimensions	Approx. 136.2 mm (W) × 97.2 mm (H) × 131.5 mm (D) [5.36" (W) × 3.83" (H) × 5.18" (D)] (excluding the projection part)
Mass (weight)	With card and battery: Approx. 810 g (1.79 lb) Excluding card and battery: Approx. 758 g (1.67 lb)
Operating temperature	0 °C to 40 °C (32 °F to 104 °F)
Operating humidity	10%RH to 80%RH
Language select	[ENGLISH] / [DEUTSCH] / [FRANÇAIS] / [ESPAÑOL] / [PORTUGUÊS] / [ITALIANO] / [繁體中文] / [日本語]

■ Wireless transmitter

Wireless LAN

Compliance standard	IEEE 802.11b/g/n (standard wireless LAN protocol)
Frequency range used (central frequency)	2412 MHz to 2462 MHz (1 to 11 ch)
Encryption method	Wi-Fi compliant WPA™/WPA2™
Access method	Infrastructure mode

Bluetooth function

Compliance standard	Bluetooth Ver. 4.2 (Bluetooth Low Energy (BLE))
Frequency range used (central frequency)	2402 MHz to 2480 MHz

■ AC adaptor

(Panasonic VSK0815F): Information for your safety

Input:	110 V – 240 V ~ 50/60 Hz 0.25 A
Output:	5.0 V = 1.8 A

■ Battery pack (lithium-ion)

(Panasonic DMW-BLC12PP): Information for your safety

Voltage/capacity:	7.2 V/1200 mAh
--------------------------	----------------

The symbols on this product (including the accessories) represent the following:

~	AC
=	DC
□	Class II equipment (The construction of the product is double-insulated.)

Specifications are subject to change without notice.

Reading the Owner's Manual (PDF format)

More detailed operating instructions are available in "Owner's Manual for advanced features (PDF format)". To read it, download it from the website.

<https://panasonic.jp/support/dsc/oi/index.html?model=DC-FZ1000M2&dest=P>



- Click the desired language.

■ Confirming URLs and QR codes with the camera

MENU →  **[Setup]** → **[Online Manual]**

Settings: [URL display] / [QR Code display]

- The URL or QR code will be displayed on the camera monitor.
- You will need Adobe Reader to browse or print the Owner's Manual (PDF format). You can download and install a version of Adobe Reader that you can use with your OS from the following website. (As of February 2019)
<http://www.adobe.com/products/acrobat/readstep2.html>

This product incorporates the following software:

- (1) the software developed independently by or for Panasonic Corporation,
- (2) the software owned by third party and licensed to Panasonic Corporation,
- (3) the software licensed under the GNU General Public License, Version 2.0 (GPL V2.0),
- (4) the software licensed under the GNU LESSER General Public License, Version 2.1 (LGPL V2.1), and/or

(5) open source software other than the software licensed under the GPL V2.0 and/or LGPL V2.1. The software categorized as (3) - (5) are distributed in the hope that it will be useful, but WITHOUT ANY WARRANTY, without even the implied warranty of MERCHANTABILITY or FITNESS FOR A PARTICULAR PURPOSE. Please refer to the detailed terms and conditions thereof displayed by selecting [MENU/SET] → [Setup] → [Version Disp.] → [Software info].

At least three (3) years from delivery of this product, Panasonic will give to any third party who contacts us at the contact information provided below, for a charge no more than our cost of physically performing source code distribution, a complete machine-readable copy of the corresponding source code covered under GPL V2.0 or LGPL V2.1, as well as the respective copyright notice thereof.

Contact Information: oss-cd-request@gg.jp.panasonic.com

The source code and the copyright notice are also available for free in our website below.

<https://panasonic.net/cns/oss/index.html>

Limited Warranty (ONLY FOR U.S.A.)

Panasonic Products Limited Warranty

Limited Warranty Coverage (For USA Only)

If your product does not work properly because of a defect in materials or workmanship, Panasonic Corporation of North America (referred to as "the warrantor") will, for the length of the period indicated on the chart below, which starts with the date of original purchase ("warranty period"), at its option either (a) repair your product with new or refurbished parts, (b) replace it with a new or a refurbished equivalent value product, or (c) refund your purchase price. The decision to repair, replace or refund will be made by the warrantor.

Product or Part Name	Parts	Labor
Digital Camera	1 Year	1 Year
All included Accessories (Except Non-Rechargeable Batteries)	90 Days	Not Applicable
Only Non-Rechargeable Batteries	10 Days	Not Applicable

During the "Labor" warranty period there will be no charge for labor. During the "Parts" warranty period, there will be no charge for parts. This Limited Warranty excludes both parts and labor for non-rechargeable batteries, antennas, and cosmetic parts (cabinet). This warranty only applies to products purchased and serviced in the United States. This warranty is extended only to the original purchaser of a new product which was not sold "as is".

Mail-In Service--Online Repair Request

Online Repair Request

To submit a new repair request and for quick repair status visit our Web Site at <http://shop.panasonic.com/support>.

When shipping the unit, carefully pack, include all supplied accessories listed in the Owner's Manual, and send it prepaid, adequately insured and packed well in a carton box. When shipping Lithium Ion batteries please visit our Web Site at

<http://shop.panasonic.com/support> as Panasonic is committed to providing the most up to date information. Include a letter detailing the complaint, a return address and provide a daytime phone number where you can be reached. A valid registered receipt is required under the Limited Warranty.

IF REPAIR IS NEEDED DURING THE WARRANTY PERIOD, THE PURCHASER WILL BE REQUIRED TO FURNISH A SALES RECEIPT/PROOF OF PURCHASE INDICATING DATE OF PURCHASE, AMOUNT PAID AND PLACE OF PURCHASE. CUSTOMER WILL BE CHARGED FOR THE REPAIR OF ANY UNIT RECEIVED WITHOUT SUCH PROOF OF PURCHASE.

Limited Warranty Limits and Exclusions

This warranty ONLY COVERS failures due to defects in materials or workmanship, and DOES NOT COVER normal wear and tear or cosmetic damage. The warranty ALSO DOES NOT COVER damages which occurred in shipment, or failures which are caused by products not supplied by the warrantor, or failures which result from accidents, misuse, abuse, neglect, mishandling, misapplication, alteration, faulty installation, set-up adjustments, misadjustment of consumer controls, improper maintenance, power line surge, lightning damage, modification, introduction of sand, humidity or liquids, commercial use such as hotel, office, restaurant, or other business or rental use of the product, or service by anyone other than a Factory Service Center or other Authorized Servicer, or damage that is attributable to acts of God.

THERE ARE NO EXPRESS WARRANTIES EXCEPT AS LISTED UNDER "LIMITED WARRANTY COVERAGE".

THE WARRANTOR IS NOT LIABLE FOR INCIDENTAL OR CONSEQUENTIAL DAMAGES RESULTING FROM THE USE OF THIS PRODUCT, OR ARISING OUT OF ANY BREACH OF THIS WARRANTY.

(As examples, this excludes damages for lost time, travel to and from the servicer, loss of or damage to media or images, data or other memory or recorded content. The items listed are not exclusive, but for illustration only.)

ALL EXPRESS AND IMPLIED WARRANTIES, INCLUDING THE WARRANTY OF MERCHANTABILITY, ARE LIMITED TO THE PERIOD OF THE LIMITED WARRANTY.

Some states do not allow the exclusion or limitation of incidental or consequential damages, or limitations on how long an implied warranty lasts, so the exclusions may not apply to you.

This warranty gives you specific legal rights and you may also have other rights which vary from state to state. If a problem with this product develops during or after the warranty period, you may contact your dealer or Service Center. If the problem is not handled to your satisfaction, then write to:

Consumer Affairs Department
Panasonic Corporation of North America
661 Independence Pkwy
Chesapeake, VA 23320

PARTS AND SERVICE, WHICH ARE NOT COVERED BY THIS LIMITED WARRANTY, ARE YOUR RESPONSIBILITY.

Shop **Accessories!**

for all your Panasonic gear

Go to

<http://shop.panasonic.com/support>

Get everything you need to get the most out of your Panasonic products
Accessories & Parts for your Camera, Phone, A/V products, TV,
Computers & Networking, Personal Care, Home Appliances, Headphones,
Batteries, Backup Chargers & more...

Customer Services Directory

For Product Information, Operating Assistance, Parts, Owner's Manuals,
Dealer and Service info go to <http://shop.panasonic.com/support>

For the hearing or speech impaired TTY: 1- 877-833-8855

As of July 2015

Limited Warranty (ONLY FOR CANADA)

Panasonic Canada Inc.

5770 Ambler Drive, Mississauga, Ontario L4W 2T3

PANASONIC PRODUCT – LIMITED WARRANTY

Panasonic Canada Inc. warrants this product to be free from defects in material and workmanship under normal use and for a period as stated below from the date of original purchase agrees to, at its option either (a) repair your product with new or refurbished parts, (b) replace it with a new or a refurbished equivalent value product, or (c) refund your purchase price. The decision to repair, replace or refund will be made by Panasonic Canada Inc.

Digital Camera	One (1) year, parts and labour
Digital Camera Peripherals	One (1) year, parts and labour
Digital Camera Accessories	Ninety (90) days, parts and labour

This warranty is given only to the original purchaser, or the person for whom it was purchased as a gift, of a Panasonic brand product mentioned above sold by an authorized Panasonic dealer in Canada and purchased and used in Canada, which product was not sold "as is", and which product was delivered to you in new condition in the original packaging.

IN ORDER TO BE ELIGIBLE TO RECEIVE WARRANTY SERVICE HEREUNDER, A PURCHASE RECEIPT OR OTHER PROOF OF DATE OF ORIGINAL PURCHASE, SHOWING AMOUNT PAID AND PLACE OF PURCHASE IS REQUIRED

LIMITATIONS AND EXCLUSIONS

This warranty **ONLY COVERS** failures due to defects in materials or workmanship, and **DOES NOT COVER** normal wear and tear or cosmetic damage. The warranty **ALSO DOES NOT COVER** damages which occurred in shipment, or failures which are caused by products not supplied by Panasonic Canada Inc., or failures which result from accidents, misuse, abuse, neglect, mishandling, misapplication, alteration, faulty installation, set-up adjustments, misadjustment of consumer controls, improper maintenance, improper batteries, power line surge, lightning damage, modification, introduction of sand, humidity or liquids, or commercial use such as hotel, office, restaurant, or other business or rental use of the product, or service by anyone other than a Authorized Servicer, or damage that is attributable to acts of God.

Dry cell batteries, printer ink cartridge and paper are also excluded from coverage under this warranty. Rechargeable batteries are warranted for ninety (90) days from date of original purchase.

THIS EXPRESS, LIMITED WARRANTY IS IN LIEU OF ALL OTHER WARRANTIES, EXPRESS OR IMPLIED, INCLUDING ANY IMPLIED WARRANTIES OF MERCHANTABILITY AND FITNESS FOR A PARTICULAR PURPOSE. IN NO EVENT WILL PANASONIC CANADA INC. BE LIABLE FOR ANY SPECIAL, INDIRECT OR CONSEQUENTIAL DAMAGES RESULTING FROM THE USE OF THIS PRODUCT OR ARISING OUT OF ANY BREACH OF ANY EXPRESS OR IMPLIED WARRANTY. (As examples, this warranty excludes damages for lost time, travel to and from the Authorized Servicer, loss of or damage to media or images, data or other memory or recorded content. This list of items is not exhaustive, but for illustration only.)

In certain instances, some jurisdictions do not allow the exclusion or limitation of incidental or consequential damages, or the exclusion of implied warranties, so the above limitations and exclusions may not be applicable. This warranty gives you specific legal rights and you may have other rights which vary depending on your province or territory.

WARRANTY SERVICE

For product operation, repairs and information assistance, please visit our Support page : www.panasonic.ca/english/support

- SDXC Logo is a trademark of SD-3C, LLC.
- The terms HDMI and HDMI High-Definition Multimedia Interface, and the HDMI Logo are trademarks or registered trademarks of HDMI Licensing Administrator, Inc. in the United States and other countries.
- HDAVI Control™ is a trademark of Panasonic Corporation.
- “AVCHD”, “AVCHD Progressive” and the “AVCHD Progressive” logo are trademarks of Panasonic Corporation and Sony Corporation.
- Dolby, Dolby Audio, and the double-D symbol are trademarks of Dolby Laboratories.
- Adobe is a trademark or registered trademark of Adobe Systems Incorporated in the United States and/or other countries.
- Pentium is a trademark of Intel Corporation in the U.S. and/or other countries.
- Windows is either registered trademark or trademark of Microsoft Corporation in the United States and/or other countries.
- iMovie, Mac, OS X and macOS are trademarks of Apple Inc., registered in the U.S. and other countries.
- iPad, iPhone, iPod, and iPod touch are trademarks of Apple Inc., registered in the U.S. and other countries.
- App Store is a service mark of Apple Inc.
- Google, Android and Google Play are trademarks of Google LLC.
- The Bluetooth® word mark and logos are registered trademarks owned by Bluetooth SIG, Inc. and any use of such marks by Panasonic Corporation is under license. Other trademarks and trade names are those of their respective owners.
- The Wi-Fi CERTIFIED™ Logo is a certification mark of Wi-Fi Alliance®.
- The Wi-Fi Protected Setup™ Logo is a certification mark of Wi-Fi Alliance®.
- “Wi-Fi®” is a registered trademark of Wi-Fi Alliance®.
- “Wi-Fi Protected Setup™”, “WPA™”, and “WPA2™” are trademarks of Wi-Fi Alliance®.
- QR Code is a registered trademark of DENSO WAVE INCORPORATED.
- This product uses “DynaFont” from DynaComware Corporation. DynaFont is a registered trademark of DynaComware Taiwan Inc.
- Other names, company names, and product names mentioned in these instructions are trademarks or registered trademarks of the companies concerned.



Panasonic Corporation of North America

Two Riverfront Plaza, Newark, NJ 07102-5490

<http://shop.panasonic.com>

Panasonic Canada Inc.

5770 Ambler Drive
Mississauga, Ontario
L4W 2T3

www.panasonic.com

© Panasonic Corporation 2019

Printed in China